

MANUAL

EVOLVEO

MODEL

VERSION / DATE

Baby Monitor NL4

1. / 20. 7. 2022



CZ

SK

EN

HU

RO

Obsah / Content / Tartalom / Cuprins

| | |
|-----------------|----|
| Česky | 3 |
| Slovensky | 25 |
| English..... | 47 |
| Magyar | 69 |
| Română..... | 91 |

Obsah







| | |
|----------------------------|----|
| VAROVÁNÍ | 4 |
| OBSAH BALENÍ | 4 |
| KAMERA | 5 |
| MONITOR | 6 |
| KAMERA | 9 |
| ZAČÍNÁME | 9 |
| NASTAVENÍ KAMERY | 11 |
| 1. PŘIDÁNÍ KAMER | 11 |
| 2. ODSTRANĚNÍ KAMERY | 12 |
| DETEKCE ZVUKU | 13 |
| TEPLOTNÍ ALARM | 14 |
| UKOLÉBAVKY | 15 |
| REŽIM SPÁNKU | 16 |
| KRMENÍ | 17 |
| DATUM / ČAS | 18 |
| NASTAVENÍ | 19 |
| VYSVĚTLENÍ IKON | 21 |
| ČASTO KLADENÉ DOTAZY | 22 |

VAROVÁNÍ

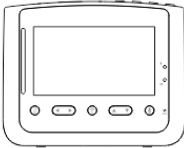
Nesprávné používání výrobku může vést k bezpečnostním rizikům. Před použitím výrobku proto důrazně doporučujeme přečíst si následující pokyny.

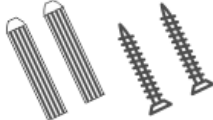
1. Držte šňůru (šňůry) mimo dosah dětí. (ve vzdálenosti min. 1 metr).
2. V případě POŠKOŽENÍ kontaktujte nejbližší servis.
3. Používejte POUZE originální adaptéry. Používání neoriginálních kabelů a adaptérů může zařízení poškodit.
4. Pokud adaptér(y) nepoužíváte, odpojte jej(je).
5. Pravidelně kontrolujte aktivity svého dítěte, protože tento výrobek není určen pro dohled, ale pro asistenci při dohledu.

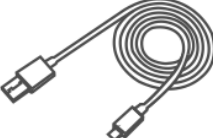
OBSAH BALENÍ

| | | | |
|--|---|---|--|
|  |  |  | |
| Monitor | Kamera | Napájecí adaptér x2 | |
|  |  |  |  |
| Montážní sada | Držák kamery | Napájecí kabel x2 | Manuál |

KAMERA

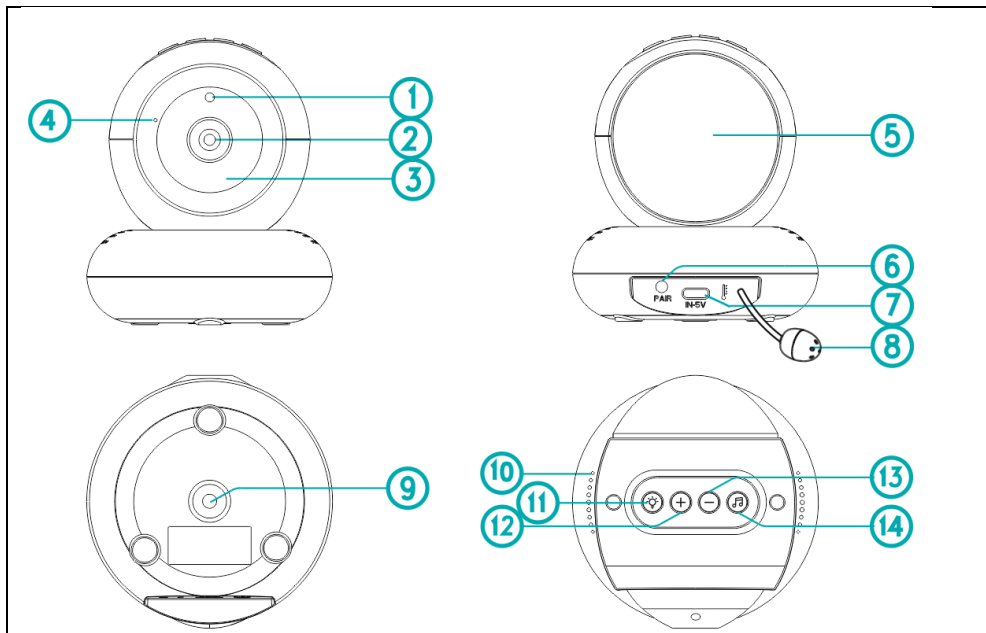

1) Senzor nočního vidění
2) Objektiv
3) IR LED
4) Mikrofon

6) Tlačítko párování
7) Napájení USB-C
8) Snímač teploty
9) Montážní držák
10) Reprodukční

11) Tlačítko LED
12) + Tlačítko
13) - Tlačítko
14) Tlačítko
ukolébavky

MONITOR

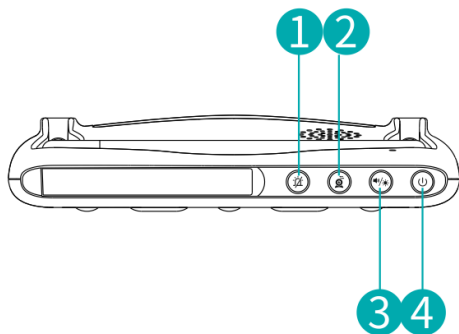

- 1) VOX: režim odposlechu, kamera se zapne na nastavený čas pohotovostního režimu a je možné sledovat dění před kamerou.
- 2) Přepínač kamery: Přepínání kamer, pokud jsou připojeny 2 nebo více kamer, lze opakovaným stiskem přepínat mezi kamerami.
- 3) Hlasitost/jas: Stisknutím upravíte hlasitost nebo jas monitoru pomocí šipek doleva/doprava a nahoru/dolů.
- 4) Tlačítko napájení/spánku: Dlouhým stisknutím zapnete/vypnete monitor; krátkým stisknutím zapnete/vypnete obrazovku.
- 5) LED panel úroveň hlasitosti: úroveň zobrazuje hlasitost a intenzitu zvuku detekovaného kamerou. Modrá > nízká, oranžová > střední, červená > vysoká.

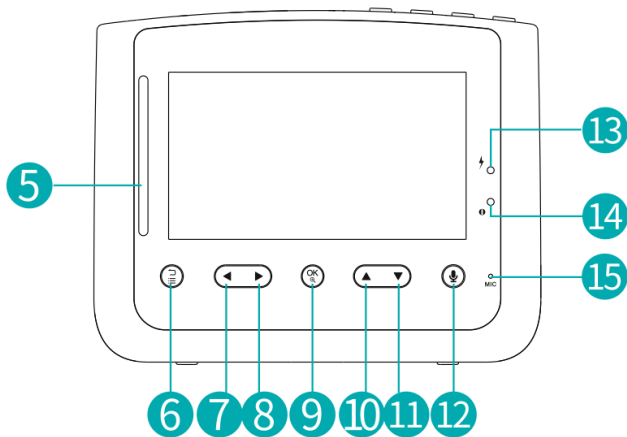

6) Menu/Zpět: Stisknutím tlačítka vstoupíte na stránku nabídky nebo stiskněte tlačítko Zpět.

7) Vlevo: Stisknutím tlačítka posunete kameru doleva nebo změníte výběr směrem doleva.

8) Vpravo: Stisknutím tlačítka posunete kameru doprava nebo změníte výběr směrem doprava.

9) Zoom/OK: Stiskněte tlačítko pro přiblížení/oddálení nebo pro potvrzení výběru.

10) Up: Stisknutím tlačítka nakloníte fotoaparát nahoru nebo změníte výběr směrem nahoru.

11) Dolů: Stisknutím tlačítka nakloníte fotoaparát směrem dolů nebo změníte výběr směrem dolů.

12) Mluvte: Stisknutím tlačítka můžete mluvit s dítětem.

- 13) Indikátor nabíjení: během nabíjení monitoru svítí žlutě.
14) Indikátor výkonu: Zelená kontrolka se rozsvítí, pokud je připojena k elektřině.
15) Mikrofon

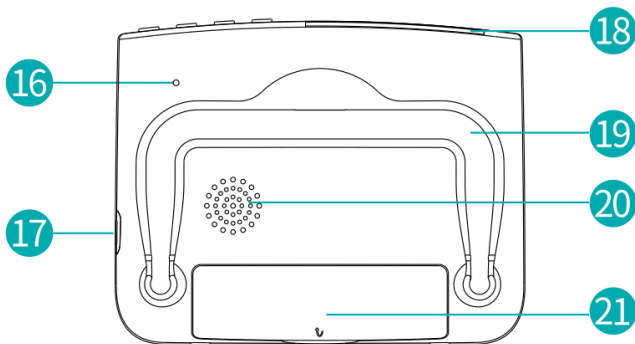

- 16) Resetovací otvor
17) Konektor napájení USB-C
18) Výklopná anténa
19) Podpěrný stojan
20) Reproduktor
21) Prostor pro baterii

Poznámka:

1. Pokud provedete RESET pomocí vývodu, monitor bude nuceně vypnut.
2. Baterii měňte pouze za originální nebo stejnou s totožnými parametry.

KAMERA

Stiskem tlačítka LED(11) zapnete lampičku, opakovaným stiskem měníte barvy. Podržením spustíte režim cyklu. Stiskem tlačítka +/- (12/13) měníte intenzitu LED osvětlení. Stiskem tlačítka ukořbavky (14) spustíte jednu z melodií, opakovaným stiskem změníte melodii. Podržením vypnete melodii. Stiskem tlačítka +/- (12/13) změníte hlasitost melodie.

ZAČÍNÁME

Krok 1:



1. Připojte kameru k adaptéru.
2. Zapijte síťový adaptér do zásuvky.

Poznámka: Umístěte kameru dál od dítěte (alespoň 1m).

Krok 2:

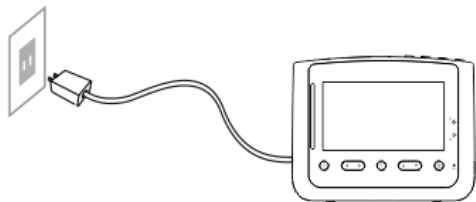

1. Připojte monitor k adaptéru.
2. Zapojte síťový adaptér do zásuvky.
3. Dlouhým stisknutím tlačítka napájení monitor zapnete a poté se zobrazí monitorovací rozhraní.

Poznámka: Plné nabití monitoru trvá cca 4 hodiny a výdrž je až 5 hodin.

NASTAVENÍ KAMERY

Upozornění: Kamera a monitor již byly spárovány. Tato funkce slouží k přidávání nových kamer do monitoru, nebo při resetu monitoru.

1. PŘIDÁNÍ KAMERY



Krok 1:

1. Stisknutím tlačítka  vstoupíte na stránku nabídky.

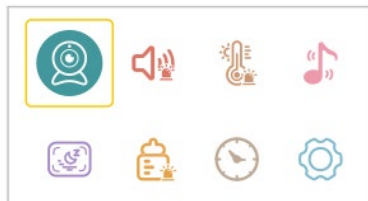
2. Vyberte  a stiskněte tlačítko .



Krok 2:

1. Vyberte  a stiskněte tlačítko .

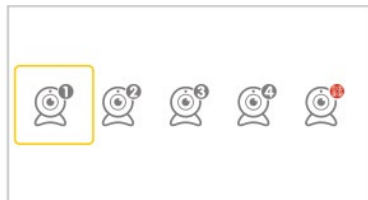

Krok 3:

1. Vyberte  a stiskněte dvakrát tlačítko .
Viz **Fotoaparát NENÍ spárován.**

2. Stisknutím tlačítka  zahájíte párování.

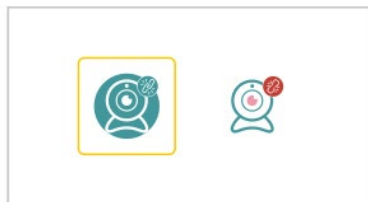



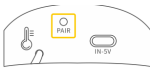

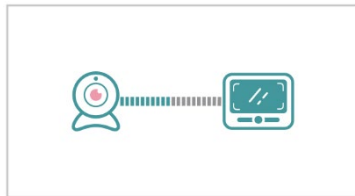
Krok 4:

1. Stisk  **PAIR** na zadní straně kamery.
 2. Poté se zobrazí výzva **Paired**.
- Poznámka:** K jednomu monitoru lze připojit maximálně čtyři kamery.



2. ODSTRANĚNÍ KAMERY

Krok 1:

1. Tisk  pro vstup na stránku nabídky. Vyberte  a stiskněte .
2. Vyberte fotoaparát, který je třeba vymazat. Tisk .

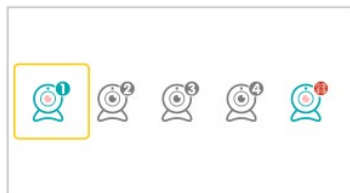
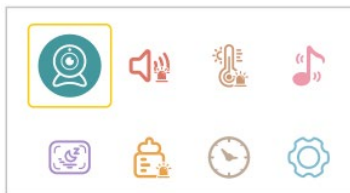

Krok 2:

1. Vyberte správnou ikonu fotoaparátu. Dvakrát stiskněte tlačítko .
2. Viz **Odstraněno**. Váš fotoaparát je vymazán.

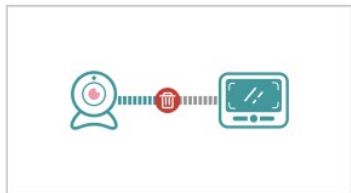
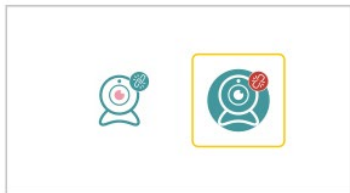





DETEKCE ZVUKU

Vysvětlení:

Existují čtyři úrovně detekce zvuku: I (78 dB), II (65 dB) III (60 dB) a OFF (vypnuto). I znamená, že zvuk lze detekovat, pokud dosáhne 78 dB, a tak dále pro II a III.

Krok 1:

1. Stisk  pro vstup na stránku nabídky. Vyberte  a stiskněte  .
2. Vyberte požadovanou možnost. Stisk 

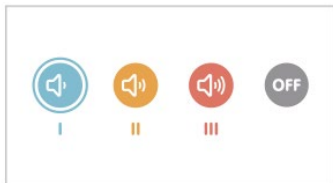
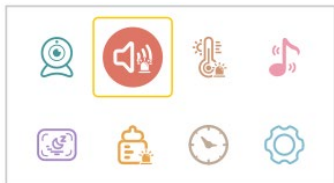





TEPLOTNÍ ALARM

Vysvětlení:



označuje, že lze nastavit hodnotu teploty pro alarmy vysoké a nízké teploty.

Krok 1:

1. Stisk  pro vstup na stránku nabídky. Zvolte  a stiskněte .
2. Vyberte požadovanou možnost. Stisk .

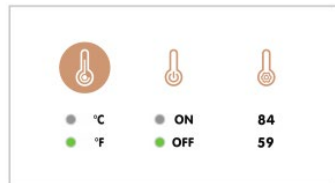
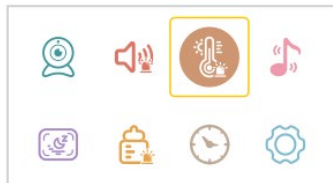

Poznámka:



Zvukový/teplotní alarm lze dočasně vypnout stisknutím libovolného tlačítka na monitoru.

UKOLÉBAVKY

Vysvětlení:

Tato funkce slouží k uklidnění dítěte v případě potřeby.

Krok 1:

1. Tisk  pro vstup na stránku nabídky. Vyberte  a stiskněte  .
2. Vyberte požadovanou ukolébavku. Výběrem možnosti **VŠE(ALL)** přehrajete ukolébavky ve smyčce.

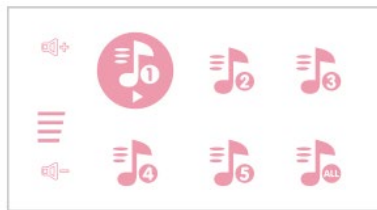
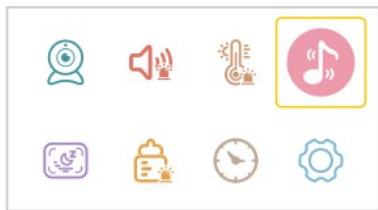



REŽIM SPÁNKU

Vysvětlení:

Tato funkce slouží k prodloužení doby provozu monitoru vypnutím obrazovky.

Krok 1:

1. Tisk  pro vstup na stránku nabídky. Vyberte  a stiskněte  .
2. Vyberte požadovaný čas.

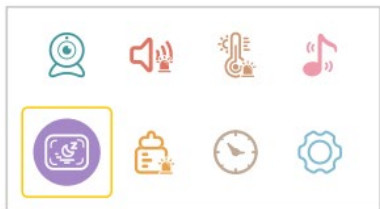

Poznámka:



Obrazovka se automaticky rozsvítí, pokud dojde ke zvukovému nebo teplotnímu alarmu.

KRMENÍ

Vysvětlení:

Tato funkce vám připomene krmení dítěte. OFF znamená, že funkci vypnete; 2,5 hodiny znamená, že vám připomene každé 2,5 hodiny, a tak dále pro ostatní možnosti.

Krok 1:

1. Tisk  pro vstup na stránku nabídky. Vyberte  a stiskněte .
2. Vyberte požadovaný čas. Výběrem možnosti VYPNUTO upomínku podávání vypnete.

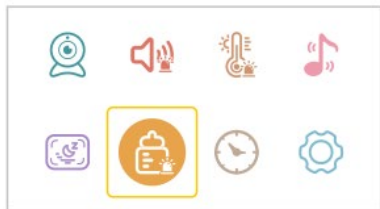





Poznámka: Výběrem možnosti  nastavíte budík na zadaný čas.

DATUM / ČAS

Vysvětlení: Tato funkce slouží k nastavení data/času, zapnutí/vypnutí .

Krok 1:

1. Tisk  pro vstup na stránku nabídky. Zvolte  a stiskněte  .
2. Stisknutím tlačítka  zahájíte/ukončíte nastavení.  znamená zahájení nastavení.

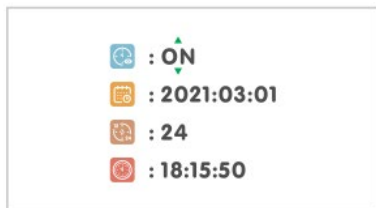
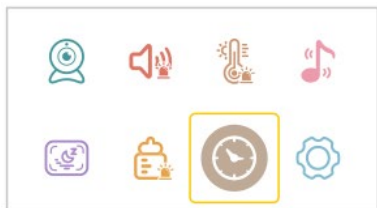

3.   znamená dokončení nastavení.

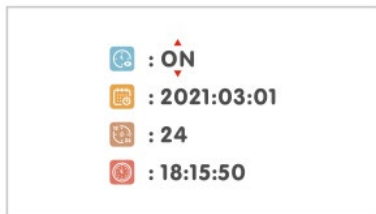

Poznámka:

* Stisknutím tlačítek **Nahoru / Dolů / Doleva / Doprava** vyberte a stisknutím tlačítka Ok potvrďte.





* Pokud je zapnuta stránka , zobrazí se datum a čas na stavovém řádku monitoru; jinak se nezobrazí.

NASTAVENÍ

Vysvětlení:

Obnovení továrního nastavení a poskytnutí informací o servisní podpoře.

Krok 1:

1. Stisk  pro vstup na stránku nabídky. Vyberte  a stiskněte .
2. Vyberte a přizpůsobte . Do rozhraní vstoupíte stisknutím tlačítka .

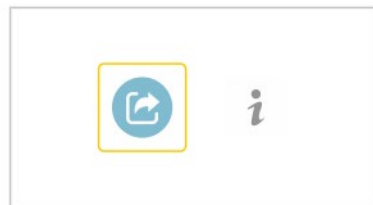
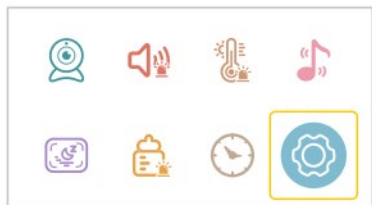

3. Vyhovuje **ANO** pro resetování. Tisk  nebo se přizpůsobte **NE** pro ukončení.

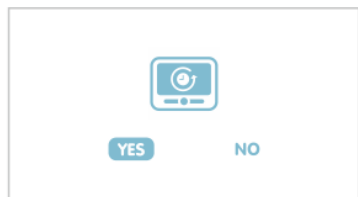



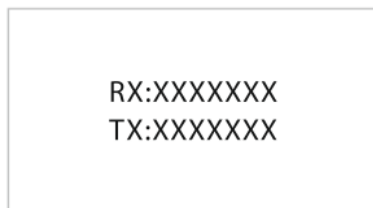
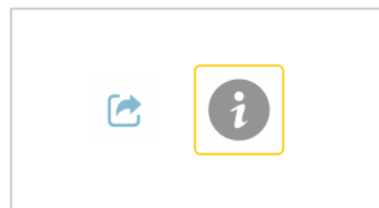





1. Vyberte . Do rozhraní vstoupíte stisknutím tlačítka .







VYSVĚTLENÍ IKON



1. Ikony stavového řádku

| | | | |
|--|---------------------------|---|-----------------------------|
|  | Žádné připojení signálu |  | Zapnutá detekce zvuku |
|  | Síla signálu |  | Teplotní alarm povolen |
|  | Smyčka živého videa |  | Připomenutí krmení povoleno |
|  | Ukolébavky povoleny |  | 2násobné zvětšení |
|  | Režim spánku povolen |  | 4násobné zvětšení |
| 27°C | Aktuální pokojová teplota |  | Noční režim |
|  | Úroveň nabití baterie | VOX | Režim VOX je zapnutý |

2. Oznámení Icons

| | | | |
|--|-----------------------------|---|-------------------|
|  | Není připojena žádná kamera |  | Teplotní alarm |
|  | Zvukový alarm |  | Oznámení o krmení |

Vysvětlení: Funkci Live-Video-Loop můžete otevřít krátkým stisknutím tlačítek na

 dokud se nezobrazí  na stavovém řádku. Když je zapnutá funkce Live-Video-Loop, připojené kamery se automaticky přepínají každých 10 sekund. A pokud dojde ke zvukovému/teplotnímu alarmu, funkce přepínače kamery se dočasně pozastaví.

ČASTO KLADENÉ DOTAZY

Q1. Proč se mi nepodařilo připojit kameru k monitoru?

- * Ujistěte se, že je napájecí adaptér pevně připojen k fotoaparátu a zásuvce.
- * Ujistěte se, že fotoaparát a monitor jsou v efektivní vzdálenosti.

Q2. Proč je živé video tak rozmazané?

- * Ujistěte se, že na objektivu fotoaparátu není žádná překážka.

Q3. Proč monitor vydával hluk?

- * Kamera a monitor mohou být příliš blízko. Umístěte je do větší vzdálenosti.

Q4. Uslyším své dítě, když vypnu obrazovku?

- * Ano. Měli byste zapnout funkci Detekce zvuku, která probudí obrazovku a spustí zvukový alarm, pokud je detekován hlasitý zvuk.

Q5. Proč je obrázek černobílý?

- * Režim nočního vidění se aktivuje, pokud kamera pracuje v tmavém prostředí (jas < 5 luxů).

Záruka se NEVZTAHUJE na:

- používání přístroje k jiným účelům, než pro které je určen,
- instalace jiného firmwaru, než který je nainstalován v zařízení.
- elektrické nebo mechanické poškození způsobené nesprávným používáním.
- poškození způsobené přírodními vlivy, jako je voda, oheň, statická elektřina, kolísání elektrického proudu apod.
- škody způsobené opravou provedenou nekvalifikovanou osobou.
- nečitelné sériové číslo
- kapacita baterie se po 6 měsících používání sníží (záruka 6 měsíců životnosti baterie)



Likvidace

Symbol přeškrtnutého kontejneru na výrobku, v přiložené dokumentaci nebo na obalu znamená, že všechna elektrická a elektronická zařízení, baterie a akumulátory v Evropské unii musí být po skončení své životnosti zlikvidovány jako tříděný odpad. Tyto výrobky se nesmí likvidovat jako netříděný komunální odpad.



PROHLÁŠENÍ O SHODĚ

Společnost Abacus Electric, s.r.o. tímto prohlašuje, že EVOLVEO Baby Monitor NL4 splňuje požadavky norem a předpisů platných pro tento typ zařízení.

Úplné znění prohlášení o shodě naleznete na adrese <http://ftp.evolveo.com/ce/>.

Dovozce
Abacus Electric, s.r.o.
Planá 2, 370 01, Česká republika

Výrobce
Naxya Limited
No. 5, 17/F, Strand 50, 50 Bonham Strand, Sheung Wan, Hongkong
Vyrobeno v Číně

Copyright © Abacus Electric, s.r.o.
www.evolveo.com
www.facebook.com/EvolveoCZ

Všechna práva vyhrazena. Vzhled a technické specifikace výrobku se mohou změnit bez předchozího upozornění.

Obsah





| | |
|------------------------------|----|
| VAROVANIE | 26 |
| OBSAH BALENIA | 26 |
| KAMERA | 27 |
| MONITOR | 28 |
| KAMERA | 31 |
| ZAČÍNAME | 31 |
| NASTAVENIA FOTOAPARÁTU | 33 |
| 1. PRIDANIE KAMIER | 33 |
| 2. ODSTRÁNENIE KAMIER | 34 |
| DETEKCIA ZVUKU | 35 |
| ALARM TEPLA | 36 |
| USPÁVANKY | 37 |
| REŽIM SPÁNKU | 38 |
| KŔMENIE | 39 |
| DÁTUM / ČAS | 40 |
| NASTAVENIA | 41 |
| VYSVETLENIE IKON | 43 |
| ČASTO KLADENÉ OTÁZKY | 44 |

VAROVANIE

Nesprávne používanie výrobku môže viesť k ohrozeniu bezpečnosti. Preto dôrazne odporúčame, aby ste si pred použitím výrobku prečítali nasledujúce pokyny.

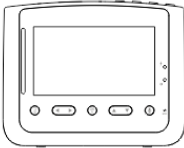
1. Šnúru (šnúry) uchovávajte mimo dosahu detí (aspoň 1 meter).
2. V prípade CHYBY kontaktujte najbližšie servisné stredisko.
3. Používajte výlučne originálne adaptéry. Používanie neoriginálnych káblov a adaptérov môže zariadenie poškodiť.
4. Ak adaptér (adaptéry) nepoužívate, odpojte ho (ich).
5. Pravidelne kontrolujte aktivity svojho dieťaťa, pretože tento výrobok nie je určený na dohľad, ale pomáhať pri dohľade.

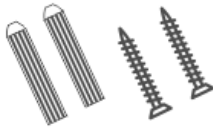
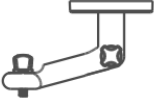
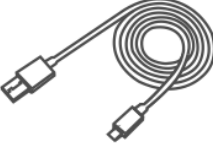
OBSAH BALENIA

| | | | |
|--|---|---|--|
|  |  |  | |
| Monitor | Kamera | Napájací adaptér x2 | |
|  |  |  |  |
| Montážna súprava | Držiak fotoaparátu | Napájací kábel x2 | Manuál |

KAMERA

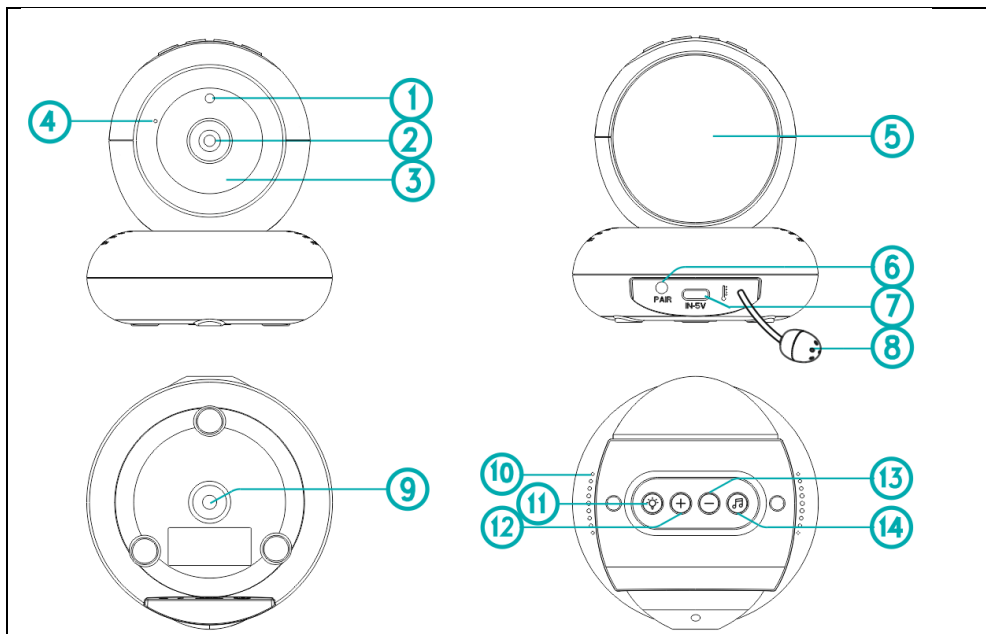

1) Senzor nočného videnia
2) Objektív
3) IR LED
4) Mikrofón
5) LED svetlo

6) Tlačidlo párovania
7) Napájanie USB-C
8) Snímač teploty
9) Montážna konzola
10) Reprodukter

11) Tlačidlo LED
12) + Tlačidlo
13) - Tlačidlo
14) Tlačidlo uspávanky

MONITOR

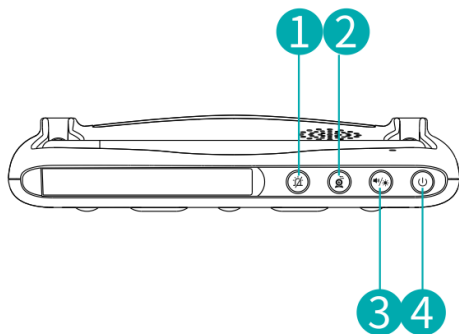

- 1) VOX: režim odpočúvania, kamera je zapnutá na nastavený čas pohotovosti a je možné sledovať dianie pred kamerou.
- 2) Prepínač kamery: Prepínanie kamier, ak sú pripojené 2 alebo viac kamier, môžete prepínať medzi kamerami opakovaným stláčaním.
- 3) Hlasitosť/jas: Stlačením tlačidla upravte hlasitosť alebo jas monitora pomocou šípok doľava/doprava a nahor/doleva.
- 4) Tlačidlo napájania/spánku: Dlhým stlačením zapnete/vypnete monitor; krátkym stlačením zapnete/vypnete obrazovku.
- 5) Úroveň hlasitosti LED panela: úroveň zobrazuje hlasitosť a intenzitu zvuku zisteného kamerou. Modrá > nízka, oranžová > stredná, červená > vysoká.

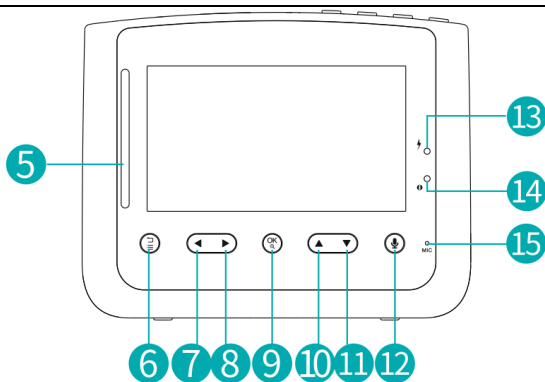

- 6) Menu/Zadné: Stlačením tlačidla vstúpte na stránku ponuky alebo stlačte tlačidlo Späť.
- 7) Vľavo: Stlačením tlačidla posuniete fotoaparát doľava alebo zmeníte výber doľava.
- 8) Vpravo: Stlačením tlačidla posuniete fotoaparát doprava alebo zmeníte výber doprava.
- 9) Zoom/OK: Stlačením tlačidla priblížite/oddialite alebo potvrdíte výber.
- 10) Up: Stlačením tlačidla nakloníte fotoaparát nahor alebo zmeníte výber smerom nahor.
- 11) Dole: Stlačením tlačidla nakloníte fotoaparát smerom nadol alebo zmeníte výber smerom nadol.
- 12) Hovorte: Stlačením tlačidla sa môžete s dieťaťom rozprávať.
- 13) Indikátor nabíjania: počas nabíjania monitora svieti žlt.
- 14) Ukazovateľ výkonnosti: Po pripojení k elektrickej sieti sa rozsvieti zelená kontrolka.
- 15) Mikrofón

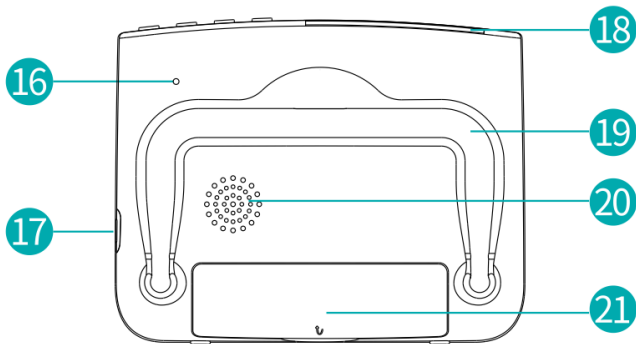

- 16) Vynulovanie otvoru
- 17) Napájací konektor USB-C
- 18) Výklopná anténa
- 19) Podporný stojan
- 20) Reproduktor
- 21) Priehradka na batérie

Poznámka:

1. Ak vykonáte RESET pomocou tohto kolíka, monitor sa násilne vypne.
2. Batériu vymeňte iba za originálnu alebo identickú batériu s rovnakými parametrami.

KAMERA

Stlačením tlačidla LED(11) zapnete lampu, opakovaným stláčaním meníte farby. Podržaním spustíte režim cyklu. Stlačením tlačidla +/- (12/13) zmeníte intenzitu osvetlenia LED. Stlačením tlačidla uspávanky (14) spustíte jednu z melódií, ďalším stlačením melódiu zmeníte. Podržaním vypnete melódiu. Stlačením tlačidla +/- (12/13) zmeníte hlasitosť melódie.

ZAČÍNAME

Krok 1:



1. Pripojte fotoaparát k adaptéru.
2. Zapojte sieťový adaptér do zásuvky.

Poznámka: Umiestnite fotoaparát ďalej od dieťaťa (aspoň 1 m).

Krok 2:

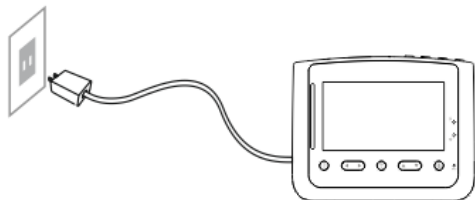

1. Pripojte monitor k adaptéru.
2. Zapojte sieťový adaptér do zásuvky.
3. Dlhým stlačením tlačidla napájania zapnite monitor a potom sa zobrazí monitorovacie rozhranie.

Poznámka: Úplné nabitie monitora trvá približne 4 hodiny a výdrž batérie je až 5 hodín.



NASTAVENIA FOTOAPARÁTU

Varovanie: Kamera a monitor už boli spárované. Táto funkcia sa používa na pridanie nových kamier do monitora alebo na resetovanie monitora.

1. Pridanie kamier

Krok 1:

1. Stlačením tlačidla  vstúpte na stránku ponuky.

2. Vyberte  a stlačte tlačidlo .

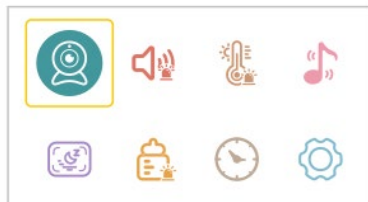

Krok 2:

1. Vyberte  a stlačte .

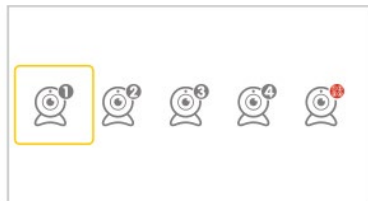

Krok 3:

1. Vyberte  a dvakrát stlačte tlačidlo .
Pozrite si časť **Fotoaparát nie je spárovaný.**

2. Stlačením tlačidla  spustíte párovanie.

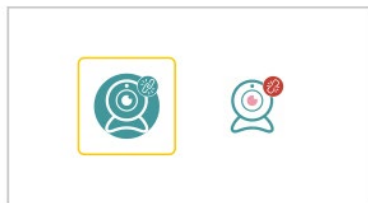

Krok 4:

1. Stlačte tlačidlo  **PAIR** na zadnej strane fotoaparátu.



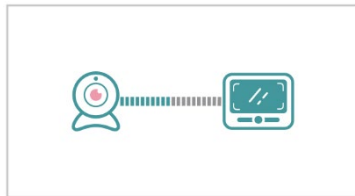

2. Potom sa zobrazí výzva **Paired**.

Poznámka: K jednému monitoru možno pripojiť maximálne štyri kamery.



2. Odstránenie kamier

Krok 1:

1. Vytlačte  a získajte prístup na stránku s ponukou. Vyberte  a stlačte **OK** .
2. Vyberte fotoaparát, ktorý sa má odstrániť. Tisk **OK** .

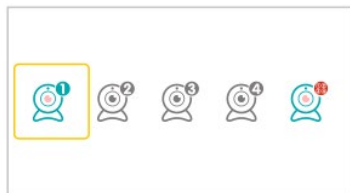
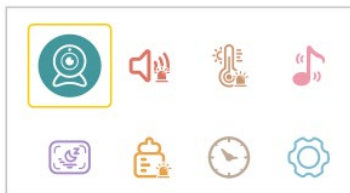

Krok 2:

1. Vyberte správnu ikonu fotoaparátu. Stlačte dvakrát tlačidlo **OK** .
2. Pozri **Odstránené**. Váš fotoaparát je vymazaný.

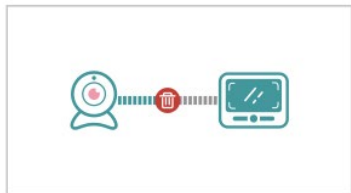
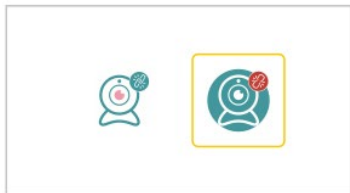





DETEKCIA ZVUKU

Vysvetlenie:

Existujú štyri úrovne detekcie zvuku: I (78 dB), II (65 dB) III (60 dB) a OFF. I znamená, že zvuk možno detekovať, keď dosiahne 78 dB, a tak ďalej pre II a III.

Krok 1:

1. Stlačením tlačidla  vstúpte na stránku ponuky. Vyberte  a stlačte .
2. Vyberte požadovanú možnosť. Stisk .

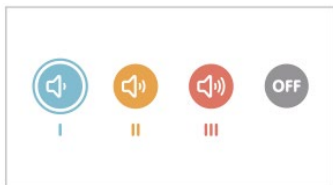
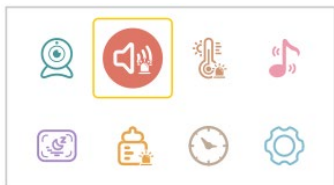





ALARM TEPLA

Vysvetlenie:

 označuje, že je možné nastaviť hodnotu teploty pre alarmy vysokej a nízkej teploty.

Krok 1:

1. Stlačením tlačidla  vstúpите na stránku ponuky. Vyberte  a stlačte .
2. Vyberte požadovanú možnosť. Stisk .

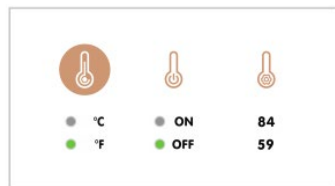
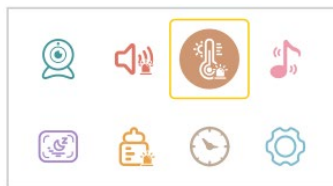

Poznámka:



Zvukový/teplotný alarm môžete dočasne vypnúť stlačením ľubovoľného tlačidla na monitore.

USPÁVANKY

Vysvetlenie:

Táto funkcia sa v prípade potreby používa na upokojenie dieťaťa.

Krok 1:

1. Vytlačte  a získajte prístup na stránku s ponukou. Vyberte  a stlačte  .
2. Vyberte požadovanú uspávanku. Ak chcete prehrávať uspávanky v slučke, vyberte položku **ALL(VŠETKO)**.

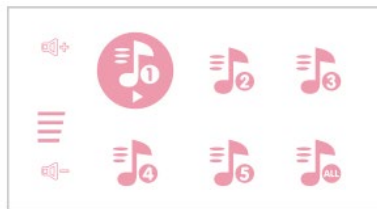
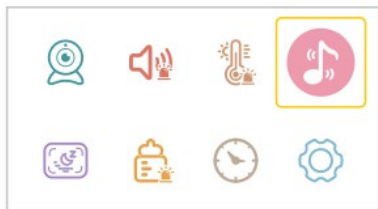



REŽIM SPÁNKU

Vysvetlenie:

Táto funkcia sa používa na predĺženie prevádzkového času monitora vypnutím obrazovky.

Krok 1:

1. Vytlačte  a získajte prístup na stránku s ponukou. Vyberte  a stlačte **OK** .
2. Vyberte požadovaný čas.

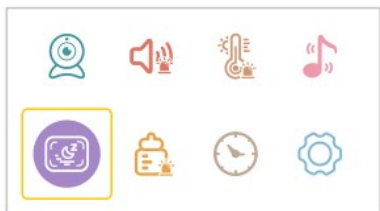

Poznámka:



Obrazovka sa automaticky rozsvieti, ak dôjde k zvukovému alebo teplotnému alarmu.

KRMENIE

Vysvetlenie:

Táto funkcia vám pripomína, aby ste kŕmili svoje dieťa. OFF znamená, že funkciu vypnete; 2,5 hodiny znamená, že vám bude pripomínať každé 2,5 hodiny, a tak ďalej pre ostatné možnosti.

Krok 1:

1. Vytlačte  a získajte prístup na stránku s ponukou. Vyberte  a stlačte  .
2. Vyberte požadovaný čas. Ak chcete pripomenutie vypnúť, vyberte možnosť OFF.

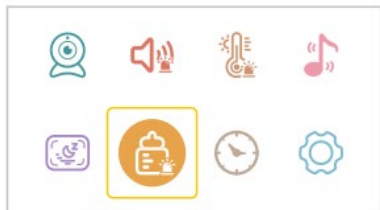





Poznámka: Výberom položky  nastavíte budík na zadaný čas.

DÁTUM / ČAS

Vysvetlenie: Táto funkcia slúži na nastavenie dátumu/času, zapnutie/vypnutie



Krok 1:

1. Vytlačte  a získajte prístup na stránku s ponukou. Vyberte  a stlačte  .
2. Stlačením tlačidla  spustíte/zastavíte nastavenie.  znamená spustenie nastavenia.

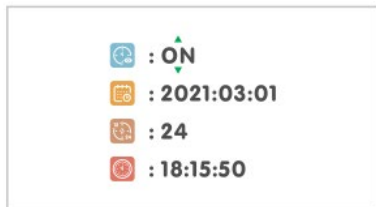
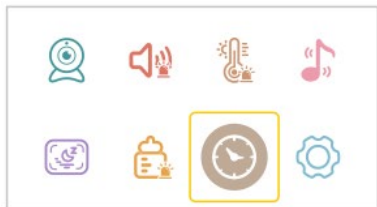

3.  znamená, že nastavenie je dokončené.

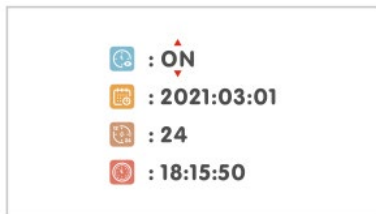

Poznámka:

* Stláčaním tlačidiel **hore** / **dole** / **doľava** / **doprava** vyberte a stlačením tlačidla **Ok** potvrdíte.





* Ak je zapnutá funkcia , dátum a čas sa zobrazí v stavovom riadku monitora; inak sa nezobrazí.

NASTAVENIA

Vysvetlenie:

Obnovenie továrenských nastavení a poskytnutie informácií o servisnej podpore.

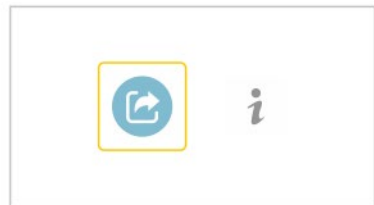
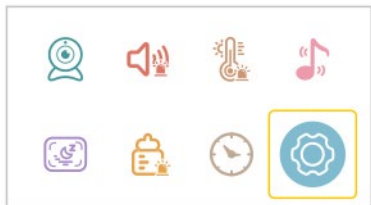

Krok 1:

1. Stlačením tlačidla  vstúpite na stránku ponuky. Vyberte  a stlačte .
2. Výber a prispôsobenie stránky . Ak chcete vstúpiť do rozhrania, stlačte tlačidlo .

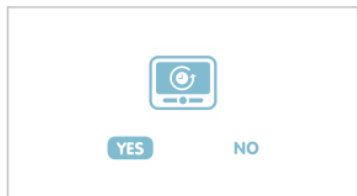

3. **ÁNO** pre resetovanie. Tlačte  alebo prispôsobte **NO** nakončenie.





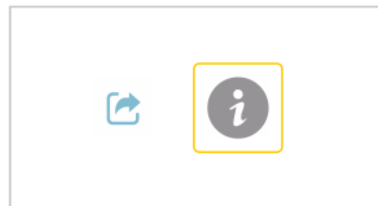









1. Vyberte . Ak chcete vstúpiť do rozhrania, stlačte tlačidlo .









VYSVETLENIE IKON

1. Ikony stavového riadka

| | | | |
|--|-------------------------------|---|----------------------------------|
|  | Žiadne pripojenie signálu |  | Detekcia zvuku na |
|  | Sila signálu |  | Zapnutý teplotný alarm |
|  | Živá video slučka |  | Pripomienky o kŕmení sú povolené |
|  | Ukolébavky povolené |  | 2-násobné zväčšenie |
|  | Režim spánku je povolený |  | Zväčšenie 4x |
| 27°C | Aktuálna teplota v miestnosti |  | Nočný režim |
|  | Úroveň nabitia batérie | VOX | Režim VOX je zapnutý |

2. Oznámenie o ikonách

| | | | |
|--|--------------------------------|---|--------------------|
|  | Nie je pripojená žiadna kamera |  | Teplotný alarm |
|  | Zvukový alarm |  | Oznámenie o kŕmení |

Vysvetlenie: Funkciu Live-Video-Loop otvoríte krátkym stlačením tlačidiel na stránke , kým sa v stavovom riadku nezobrazí . Keď je zapnutá funkcia Live-Video-Loop, pripojené kamery sa automaticky prepínajú každých 10 sekúnd. A ak dôjde k zvukovému/teplotnému alarmu, funkcia spínača kamery sa dočasne pozastaví.

ČASTO KLADENÉ OTÁZKY

Q1. Prečo som nemohol pripojiť kameru k monitoru?

* Uistite sa, že je napájací adaptér pevne pripojený k fotoaparátu a elektrickej zásuvke.

* Uistite sa, že kamera a monitor sú v efektívnej vzdialenosti.

Q2. Prečo je živé video také rozmazané?

* Uistite sa, že na objektíve fotoaparátu nie sú žiadne prekážky.

Q3. Prečo monitor vydával hluk?

* Kamera a monitor môžu byť príliš blízko. Umiestnite ich do väčšej vzdialenosti.

Q4. Môžem počuť svoje dieťa, ak vypnem obrazovku?

* Áno. Mali by ste zapnúť funkciu Detekcia zvuku, ktorá prebudí obrazovku a spustí zvukový alarm, ak sa zistí hlasný zvuk.

Q5. Prečo je obrázok čiernobiely?

* Režim nočného videnia sa aktivuje, keď kamera pracuje v tmavom prostredí (jas

< 5 luxov).

Záruka sa NEvzťahuje na:

- používať zariadenie na iné účely, než na ktoré je určené,
- inštaláciu iného firmvéru, ako je nainštalovaný v zariadení.
- elektrické alebo mechanické poškodenie spôsobené nesprávnym používaním.
- poškodenie spôsobené prírodnými vplyvmi, ako je voda, oheň, statická elektrina, kolísanie napätia atď.
- škody spôsobené opravami vykonanými nekvalifikovanou osobou.
- nečitateľné sériové číslo
- kapacita batérie sa zníži po 6 mesiacoch používania (záruka 6 mesiacov)



Likvidácia

Symbol preškrtnutého kontajnera na výrobku, v sprievodnej dokumentácii alebo na obale znamená, že všetky elektrické a elektronické zariadenia, batérie a akumulátory v Európskej únii sa musia po skončení životnosti likvidovať ako separovaný odpad. Tieto výrobky sa nesmú likvidovať ako netriedený komunálny odpad.



VYHLÁSENIE O ZHODE

Spoločnosť Abacus Electric, s.r.o. týmto vyhlasuje, že EVOLVEO Baby Monitor NL4 spĺňa požiadavky noriem a predpisov platných pre tento typ zariadení.

Úplné znenie vyhlásenia o zhode nájdete na adrese <http://ftp.evolveo.com/ce/>.

Dovozca

Abacus Electric, s.r.o.

Planá 2, 370 01, Česká republika

Výrobca

Naxya Limited

No. 5, 17/F, Strand 50, 50 Bonham Strand, Sheung Wan, Hongkong

Vyrobené v Číne

Copyright © Abacus Electric, s.r.o.

www.evolveo.com

www.facebook.com/EvolveoCZ

Všetky práva vyhradené. Vzhľad a technické špecifikácie výrobku sa môžu zmeniť bez predchádzajúceho upozornenia.

Contents







| | |
|----------------------------------|----|
| WARNING | 48 |
| PACKAGING CONTENT | 48 |
| CAMERA | 49 |
| MONITOR | 50 |
| CAMERA | 53 |
| GETTING STARTED | 53 |
| CAMERA SETTINGS | 55 |
| 1. ADDING CAMERAS | 55 |
| 2. REMOVING CAMERAS | 56 |
| SOUND DETECTION | 57 |
| HEAT ALARM | 58 |
| LULLABIES | 59 |
| SLEEP MODE | 60 |
| FEEDING | 61 |
| DATE / TIME | 62 |
| SETTINGS | 63 |
| EXPLANATION OF ICONS | 65 |
| FREQUENTLY ASKED QUESTIONS | 66 |

WARNING

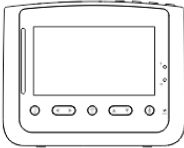
Improper use of the product can lead to safety hazards. We therefore strongly recommend that you read the following instructions before using the product.

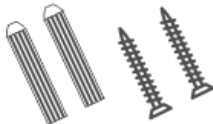
1. Keep the cord(s) out of the reach of children (at least 1 metre away).
2. In the event of a MISTAKE, please contact the nearest service centre.
3. Use ONLY original adapters. Using non-original cables and adapters can damage the device.
4. If you are not using the adapter(s), unplug it(them).
5. Check your child's activities regularly as this product is not intended for supervision, but to assist in supervision.

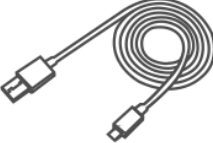
PACKAGING CONTENT

| | | |
|--|---|---|
|  |  |  |
| Monitor | Camera | Power adapter x2 |
|  |  |  |
| Mounting kit | Camera holder | Power cable x2 |
|  | | |
| Manual | | |

CAMERA

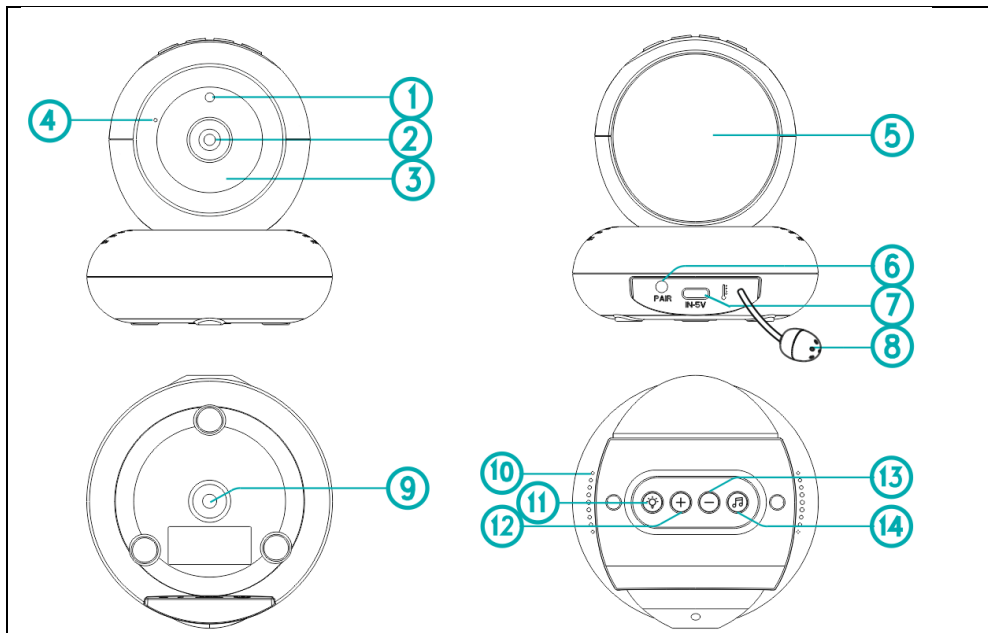

1) Night vision sensor

2) Lens

3) IR LED

4) Microphone

5) LED light

6) Pairing button

7) USB-C power supply

8) Temperature sensor

9) Mounting bracket

10) Speaker

11) LED button

12) + Button

13) - Button

14) Lullaby button

MONITOR

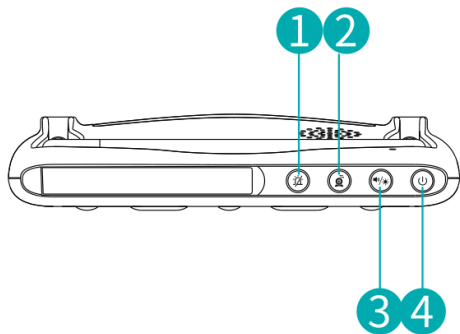

- 1) VOX: eavesdropping mode, the camera is switched on for the set standby time and it is possible to monitor the events in front of the camera.
- 2) Camera switch: Camera switching, if 2 or more cameras are connected, you can switch between cameras by repeatedly pressing.
- 3) Volume/Brightness: Press to adjust the monitor volume or brightness using the left/right and up/down arrows.
- 4) Power/Sleep button: Long press to turn the monitor on/off; short press to turn the screen on/off.
- 5) LED panel volume level: the level displays the volume and intensity of the sound detected by the camera. Blue > low, orange > medium, red > high.

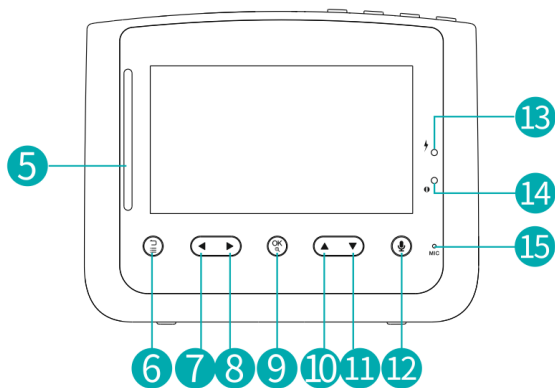

- 6) Menu/Back: Press the button to enter the menu page or press the Back button.
- 7) Left: Press the button to move the camera to the left or change the selection to the left.
- 8) Right: Press the button to move the camera to the right or change the selection to the right.
- 9) Zoom/OK: Press the button to zoom in/out or to confirm the selection.
- 10) Up: Press the button to tilt the camera up or change the selection upwards.
- 11) Down: Press the button to tilt the camera downwards or change the selection downwards.
- 12) Mluvte: Press the button to talk to the child.
- 13) Charging indicator: lights yellow while the monitor is charging.
- 14) Performance indicator: The green light will come on when it is connected to electricity.
- 15) Mikrofon

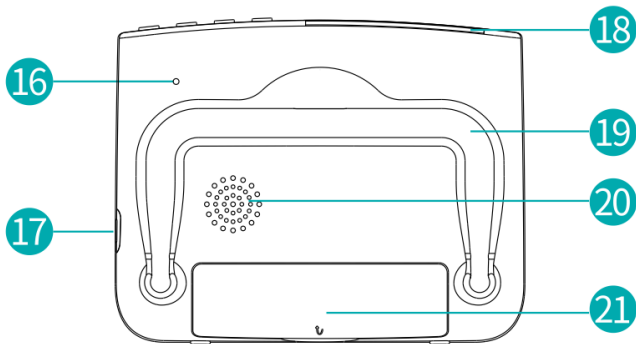

- 16) Reset hole
- 17) USB-C power connector
- 18) Tilting antenna
- 19) Support stand
- 20) Speaker
- 21) Battery compartment

Remark:

1. If you perform a RESET using the pin, the monitor will be forcibly turned off.
2. Only replace the battery with an original or identical battery with identical specifications.

Camera

Press the LED button(11) to switch on the lamp, press it repeatedly to change the colours. Hold to start the cycle mode. Press the +/- (12/13) button to change the intensity of the LED lighting. Press the lullaby button (14) to start one of the melodies, press again to change the melody. Hold to switch off the melody. Press the +/- (12/13) button to change the melody volume.

GETTING STARTED

Step 1:



1. Connect the camera to the adapter.
2. Plug the mains adapter into a socket.

Remark: Place the camera away from the child (at least 1m).

Step 2:

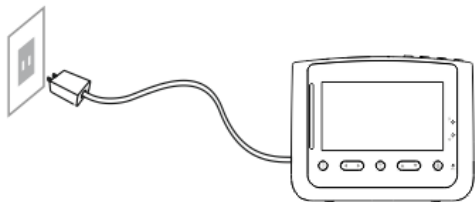

1. Connect the monitor to the adapter.
2. Plug the mains adapter into a socket.
3. Long press the power button to turn on the monitor, and then the monitoring interface is displayed.



Remark: The monitor takes about 4 hours to fully charge and the battery life is up to 5 hours.

CAMERA SETTINGS

Warning: The camera and monitor have already been paired. This function is used to add new cameras to the monitor or to reset the monitor.

1. Adding cameras

Step 1:

1. Press the  button to enter the menu page.
2. Select  and press the button .

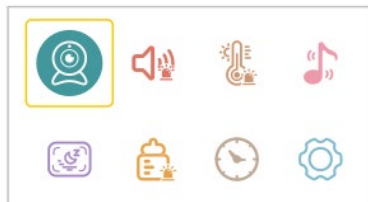

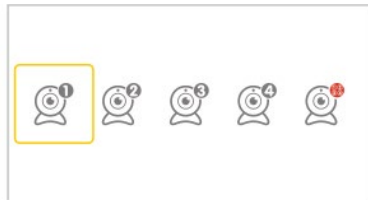

Step 2:

1. Select  and press .



Step 3:

1. Select  and press the  button twice.
See **Camera NOT paired**.
2. Press  to start pairing.

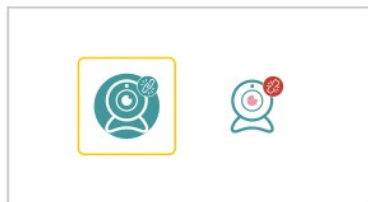



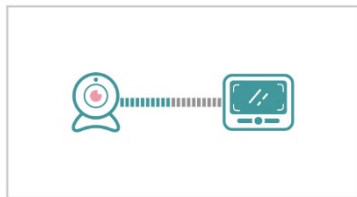

Step 4:

1. Press  **PAIR** on the back of the camera.
2. The **Paired** prompt will then appear.
Remark: A maximum of four cameras can be connected to one monitor.



2. Removing cameras

Step 1:

1. Print  to access the offer page. Select  and press .
2. Select the camera that needs to be deleted. Printed from .

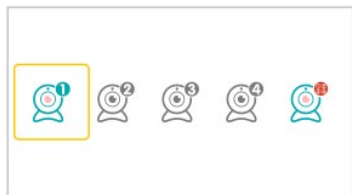
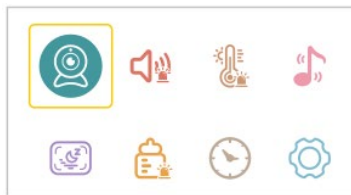

Step 2:

1. Select the correct camera icon. Press the  button twice.
2. See **Removed**. Your camera is deleted.

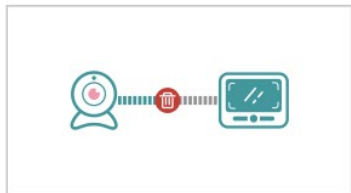
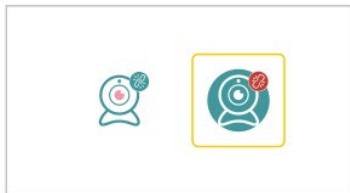





SOUND DETECTION

Explanation:

There are four levels of sound detection: I (78 dB), II (65 dB) III (60 dB) and OFF. I means that sound can be detected when it reaches 78 dB, and so on for II and III.

Step 1:

1. Press  to enter the menu page. Select  and press .
2. Select the desired option. Press .

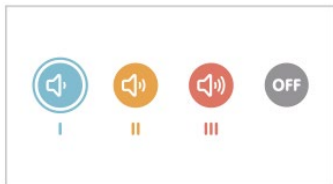
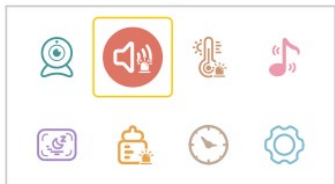

HEAT ALARM

Explanation:



indicates that the temperature value for high and low temperature alarms can be set.

Step 1:

1. Press to access the menu page. Select and press .
2. Select the desired option. Press .

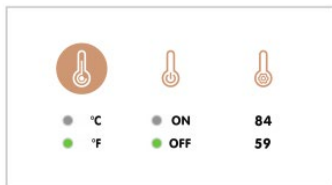
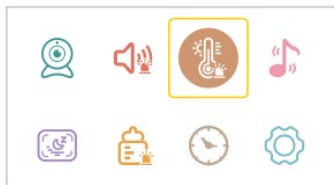

Remark:



The sound/temperature alarm can be temporarily disabled by pressing any button on the monitor.

LULLABIES

Explanation:

This function is used to calm the child when needed.

Step 1:

1. Print  to access the offer page. Select  and press  .
2. Select the desired lullaby. Select **ALL(ALL)** to play the lullabies in a loop.

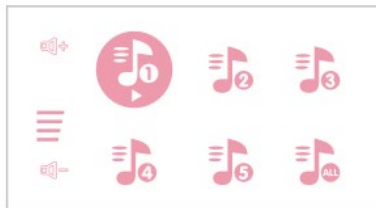
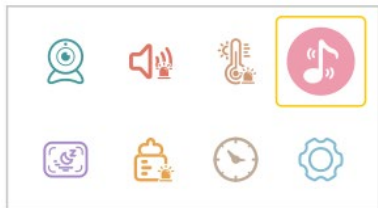



SLEEP MODE

Explanation:

This function is used to extend the monitor's operating time by turning off the screen.

Step 1:

1. Print  to access the offer page. Select  and press **OK** .
2. Select the desired time.

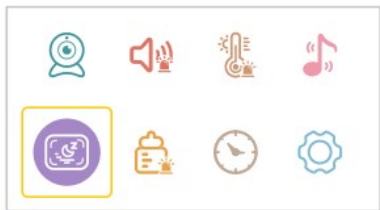

Remark:



The screen will automatically light up if an audible or temperature alarm occurs.

FEEDING

Explanation:

This feature reminds you to feed your baby. OFF means you turn the function off; 2.5 hours means it will remind you every 2.5 hours, and so on for the other options.

Step 1:

1. Press  to access the offer page. Select  and press .
2. Select the desired time. Select OFF to turn off the reminder.







Remark: Select  to set the alarm for the specified time.



DATE / TIME

Explanation: This function is used to set the date/time, turn on/off .

Step 1:

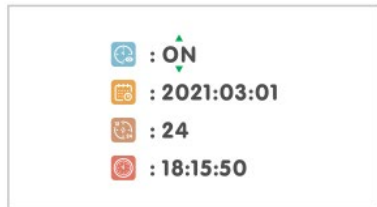
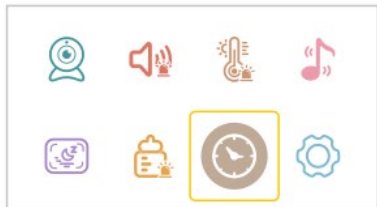
1. Print  to access the offer page. Select  and press .
2. Press the  button to start/stop the setup.  means start the setup.



3.   means the setup is complete.



Remark:

* Press the **Up / Down / Left / Right** buttons to select and press the Ok button to confirm.





* If  is enabled, the date and time will be displayed in the status bar of the monitor; otherwise it will not be displayed.

SETTINGS

Explanation:

Restore factory settings and provide service support information.

Step 1:

1. Press  to access the menu page. Select  and press .
2. Select and customize . To access the interface, press the  button.



3. **YES** for reset. Print  or customize **NO** to exit.





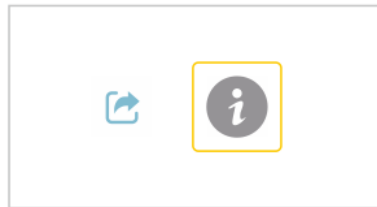









1. Select *i*. To access the interface, press the ^{OK}  button.









EXPLANATION OF ICONS

1. Status bar icons

| | | | |
|--|--------------------------|---|---------------------------|
|  | No signal connection |  | Sound detection on |
|  | Signal strength |  | Temperature alarm enabled |
|  | Live Video Loop |  | Feeding reminders allowed |
|  | Lullabies allowed |  | 2x magnification |
|  | Sleep mode enabled |  | 4x magnification |
| 27°C | Current room temperature |  | Night mode |
|  | Battery charge level | VOX | VOX mode is on |

2. Notification of Icons

| | | | |
|--|---------------------|---|-------------------------|
|  | No camera connected |  | Temperature alarm |
|  | Audible alarm |  | Notification of feeding |

Explanation: You can open the Live-Video-Loop function by briefly pressing the buttons on  until  appears in the status bar. When Live-Video-Loop is enabled, the connected cameras automatically switch every 10 seconds. And if an audible/temperature alarm occurs, the camera switch function is temporarily suspended.

FREQUENTLY ASKED QUESTIONS

Q1. Why couldn't I connect the camera to the monitor?

- * Make sure the power adapter is firmly connected to the camera and the power outlet.
- * Make sure the camera and monitor are at an effective distance.

Q2. Why is the live video so blurry?

- * Make sure there is no obstruction on the camera lens.

Q3. Why was the monitor making noise?

- * Camera and monitor may be too close. Place them at a greater distance.

Q4. Can I hear my baby if I turn off the screen?

- * Yes. You should enable the Sound Detection feature, which wakes up the screen and triggers an audible alarm if a loud sound is detected.

Q5. Why is the picture black and white?

- * Night vision mode is activated when the camera is operating in a dark

environment (brightness < 5 lux).

The warranty does NOT cover:

- using the device for purposes other than those for which it is intended,
- installing firmware other than that installed on the device.
- electrical or mechanical damage caused by improper use.
- damage caused by natural influences such as water, fire, static electricity, power fluctuations, etc.
- damage caused by repairs carried out by an unqualified person.
- illegible serial number
- battery capacity will decrease after 6 months of use (6 month battery life guarantee)



Disposal

The crossed-out container symbol on the product, in the accompanying documentation or on the packaging means that all electrical and electronic equipment, batteries and accumulators in the European Union must be disposed of as separated waste at the end of their life. These products must not be disposed of as unsorted municipal waste.



DECLARATION OF CONFORMITY

Abacus Electric, s.r.o. hereby declares that the EVOLVEO Baby Monitor NL4 meets the requirements of the standards and regulations applicable to this type of equipment.

The full text of the Declaration of Conformity can be found at
<http://ftp.evolveo.com/ce/>.

Importer
Abacus Electric, s.r.o.
Planá 2, 370 01, Czech Republic

Producer
Naxya Limited
No. 5, 17/F, Strand 50, 50 Bonham Strand, Sheung Wan, Hongkong
Made in China

Copyright © Abacus Electric, s.r.o.
www.evolveo.com
www.facebook.com/EvolveoCZ

All rights reserved. Product appearance and technical specifications are subject to change without notice.

Tartalom







| | |
|---------------------------------|----|
| FIGYELMEZTETÉS | 70 |
| A CSOMAGOLÁS TARTALMA | 70 |
| CAMERA | 71 |
| MONITOR | 72 |
| KAMERA | 75 |
| KEZDET BEN | 75 |
| KAMERA BEÁLLÍTÁSAI | 77 |
| 1. KAMERÁK HOZZÁADÁSA | 77 |
| 2. KAMERÁK ELTÁVOLÍTÁSA | 78 |
| HANGÉRZÉKELÉS | 79 |
| HŐSZÍNHÁZ-ÉRZÉKELŐ | 80 |
| ALTATÓDALOK | 81 |
| ALVÓ ÜZEMMÓD | 82 |
| ETETÉS | 83 |
| DÁTUM / IDŐ | 84 |
| BEÁLLÍTÁSOK | 85 |
| AZ IKONOK MAGYARÁZATA | 87 |
| GYAKRAN ISMÉTELT KÉRDÉSEK | 88 |

FIGYELMEZTETÉS

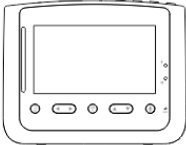
A termék nem megfelelő használata biztonsági kockázatot jelenthet. Ezért erősen javasoljuk, hogy a termék használata előtt olvassa el az alábbi utasításokat.

1. Tartsa a vezeték(ek)et gyermekek számára elérhetetlen távolságban (legalább 1 méter távolságban).
2. HIBA esetén forduljon a legközelebbi szervizközponthoz.
3. Kizárólag eredeti adaptereket használjon. A nem eredeti kábelek és adapterek használata károsíthatja a készüléket.
4. Ha nem használja az adapter(ek)e)t, húzza ki azt (azokat).
5. Rendszeresen ellenőrizze gyermeke tevékenységét, mivel ez a termék nem arra szolgál, hogy felügyelet, hanem a felügyelet segítése.

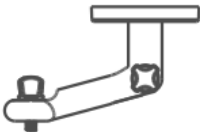
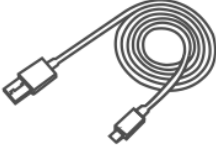
A CSOMAGOLÁS TARTALMA

| | | | |
|--|---|---|--|
|  |  |  | |
| Monitor | Kamera | Tápegység x2 | |
|  |  |  |  |
| Szerelőkészlet | Fényképezőgép tartó | Tápkábel x2 | Kézi |

CAMERA

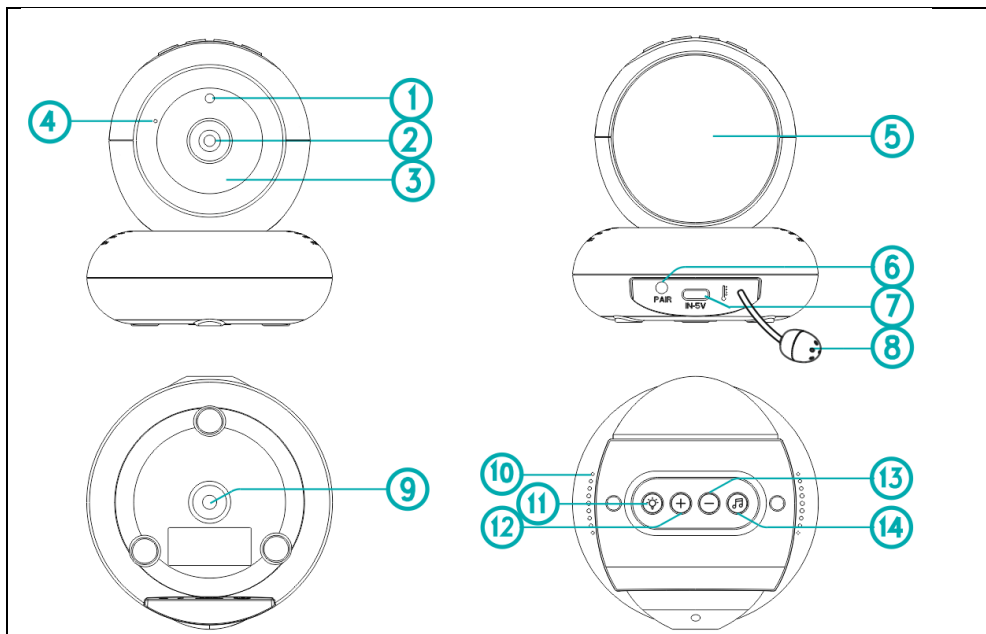

1) Éjjellátó érzékelő

2) Objektív

3) IR LED

4) Mikrofon

5) LED fény

6) Párosítás gomb

7) USB-C tápegység

8) Hőmérséklet-érzékelő

9) Tartókonzol

10) Hangszóró

11) LED gomb

12) + gomb

13) - Gomb

14) Altató gomb

MONITOR

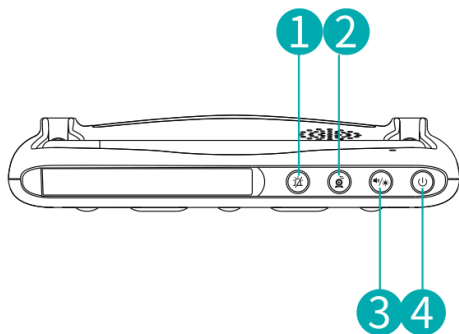

- 1) VOX: lehallgatási mód, a kamera a beállított készenléti időre bekapcsol, és lehetőség van a kamera előtt zajló események megfigyelésére.
- 2) Kamerakapcsoló: Kameraváltás, ha 2 vagy több kamera van csatlakoztatva, akkor a kamerák között a gomb ismételt megnyomásával válthat.
- 3) Hangerő/világosság: Nyomja meg a gombot a monitor hangerejének vagy fényerejének beállításához a balra/jobbra és fel/le nyilak segítségével.
- 4) Bekapcsoló/alvó gomb: Hosszan nyomja meg a monitor be/ki kapcsolásához; rövid nyomással a képernyő be/ki kapcsolásához.
- 5) LED panel hangerőszint: a szint a kamera által érzékelt hangerősséget és intenzitást mutatja. Kék > alacsony, narancssárga > közepes, piros > magas.

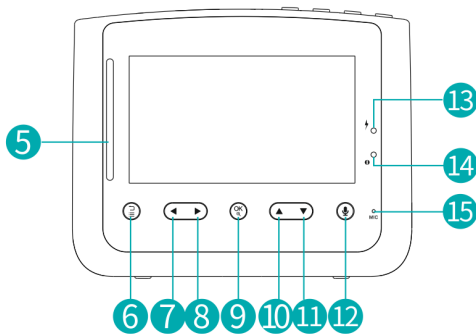

- 6) Menü/Back: Nyomja meg a gombot a menüoldalra való belépéshez, vagy nyomja meg a Vissza gombot.
- 7) Balra: Nyomja meg a gombot a kamera balra mozgatásához vagy a kijelölés balra történő módosításához.
- 8) Rendben: Nyomja meg a gombot a kamera jobbra mozgatásához vagy a kiválasztás jobbra történő módosításához.
- 9) Zoom/OK: Nyomja meg a gombot a nagyításhoz/ kicsinyítéshez vagy a kiválasztás megerősítéséhez.
- 10) Up: Nyomja meg a gombot a kamera felfelé billentéséhez vagy a kiválasztás felfelé történő módosításához.
- 11) Le: Nyomja meg a gombot a kamera lefelé billentéséhez vagy a kiválasztás lefelé történő módosításához.
- 12) Beszéljen: Nyomja meg a gombot, hogy beszéljen a gyermekkel.
- 13) Töltésjelző: sárgán világít, amíg a monitor töltődik.
- 14) Teljesítménymutató: A zöld lámpa akkor világít, ha a készülék áramhoz van csatlakoztatva.
- 15) Mikrofon

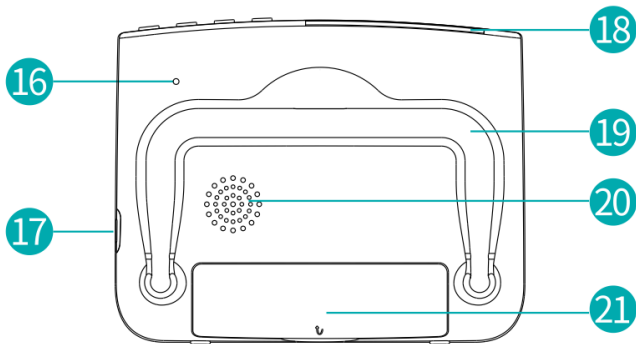

- 16) Nyílás visszaállítása
- 17) USB-C tápcsatlakozó
- 18) Dönthető antenna
- 19) Támasztóállvány
- 20) Hangszóró
- 21) Akkumulátorrekesz

Megjegyzés:

1. Ha RESET-et hajt végre a pin segítségével, a monitor erőszakosan kikapcsol.
2. Az akkumulátort csak eredeti vagy azonos specifikációjú akkumulátorral cserélje ki.

KAMERA

Nyomja meg a LED gombot(11) a lámpa bekapcsolásához, a színek megváltoztatásához nyomja meg többször. Tartsa lenyomva a ciklus üzemmód elindításához. Nyomja meg a +/- (12/13) gombot a LED-világítás intenzitásának módosításához. Nyomja meg az altatódal gombot (14) az egyik dallam elindításához, a dallam megváltoztatásához nyomja meg újra. Tartsa lenyomva a dallam kikapcsolásához. Nyomja meg a +/- (12/13) gombot a dallam hangerejének módosításához.

KEZDET BEN

1. lépés



1. Csatlakoztassa a kamerát az adapterhez.
2. Csatlakoztassa a hálózati adaptert egy konnektorba.

Megjegyzés: Helyezze a kamerát a gyermektől távolabb (legalább 1 m-re).

2. lépés:

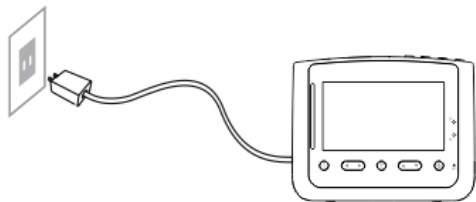

1. Csatlakoztassa a monitort az adapterhez.
2. Csatlakoztassa a hálózati adaptert egy konnektorba.
3. Nyomja meg hosszan a bekapcsológombot a monitor bekapcsolásához, majd megjelenik a felügyeleti felület.

Megjegyzés: A monitor teljes feltöltése körülbelül 4 órát vesz igénybe, az akkumulátor élettartama pedig akár 5 óra is lehet.

KAMERA BEÁLLÍTÁSAI

Figyelmeztetés: A kamera és a monitor már párosítva van. Ez a funkció új kamerák hozzáadására vagy a monitor alaphelyzetbe állítására szolgál.

1. Kamerák hozzáadása

1. lépés:



1. Nyomja meg a  gombot a menüoldalra való belépéshez.

2. Válassza ki a  lehetőséget, és nyomja meg a  gombot.

2. lépés:

1. Válassza ki a  címet, és nyomja meg a  gombot.

3. lépés

1. Válassza ki a  lehetőséget, és nyomja meg kétszer a  gombot. Lásd **NEM párosított kamera**.

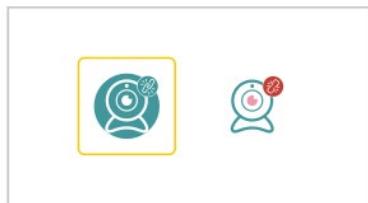
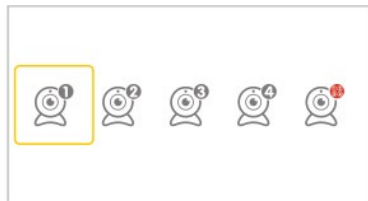
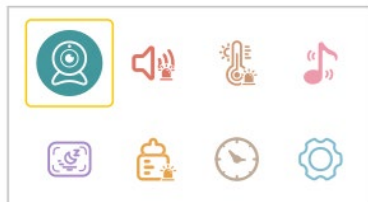

2. A párosítás megkezdéséhez nyomja meg a  gombot.

4. lépés

1. Nyomja meg a  **PAIR** gombot a kamera hátoldalán.

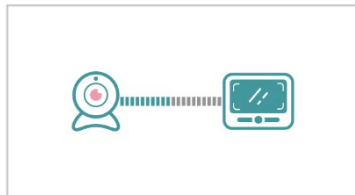

2. Ezután megjelenik a **Párosított** kérés.

Megjegyzés: Egy monitorhoz legfeljebb négy kamera csatlakoztatható.



2. Kamerák eltávolítása

1. lépés

1. Nyomtassa ki a  az ajánlati oldal eléréséhez. Válassza ki a  címet, és nyomja meg a  gombot.

2. Válassza ki a törlendő kamerát. Nyomatva a  oldalról.

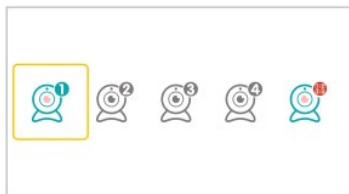
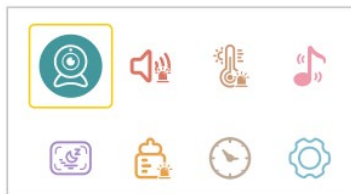

2. lépés:

1. Válassza ki a megfelelő kamera ikonját. Nyomja meg kétszer a  gombot.
2. Lásd: **Eltávolítva**. A kamerát törölték.

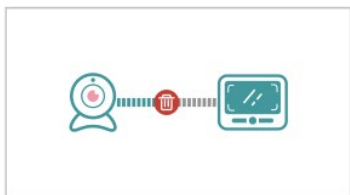
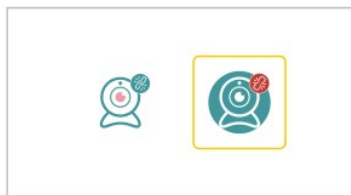





HANGÉRZÉKELÉS

Magyarázat:

A hangérzékelésnek négy szintje van: **I** (78 dB), **II** (65 dB) **III** (60 dB) és OFF. **I** azt jelenti, hogy a hang akkor érzékelhető, ha eléri a 78 dB-t, és így tovább az **II** és **III** esetében.

1. lépés

1. Nyomja meg a  gombot a menüoldalra való belépéshez. Válassza ki a  címet, és nyomja meg a  gombot.
2. Válassza ki a kívánt opciót. Sajtó 

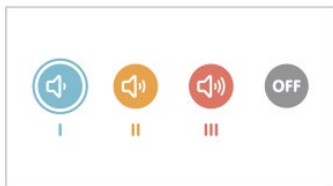
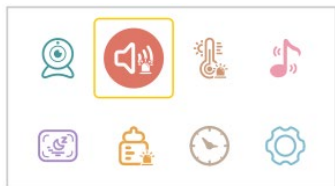





HŐSZÍNHÁZ-ÉRZÉKELŐ

Magyarázat:

 azt jelzi, hogy a magas és alacsony hőmérséklet riasztások hőmérsékletértéke beállítható.

1. lépés

1. Nyomja meg a  gombot a menüoldal eléréséhez. Válassza ki a  címet, és nyomja meg a  gombot.

2. Válassza ki a kívánt opciót. Sajtó  .

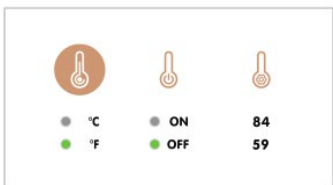
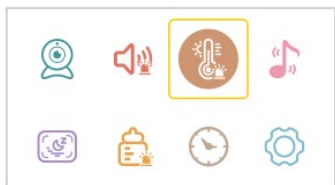

Megjegyzés:



A hang/hőmérséklet riasztás ideiglenesen kikapcsolható a monitor bármelyik gombjának megnyomásával.

Altatódalok

Magyarázat:

Ez a funkció a gyermek megnyugtására szolgál, ha szükséges.

1. lépés

1. Nyomtassa ki a  az ajánlati oldal eléréséhez. Válassza ki a  címet, és nyomja meg a  gombot.

2. Válassza ki a kívánt altatódalt. Válassza az **ALL(MINDEN)** lehetőséget az altatódalok hurokban történő lejátszásához.

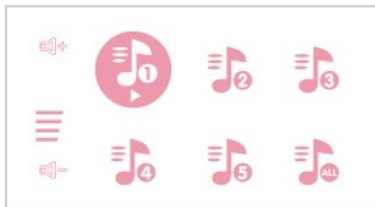
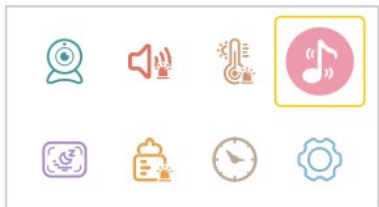



ALVÓ ÜZEMMÓD

Magyarázat:

Ez a funkció a monitor üzemidejének meghosszabbítására szolgál a képernyő kikapcsolásával.

1. lépés

1. Nyomtassa ki a  az ajánlati oldal eléréséhez. Válassza ki a  címet, és nyomja meg a  gombot.

2. Válassza ki a kívánt időt.

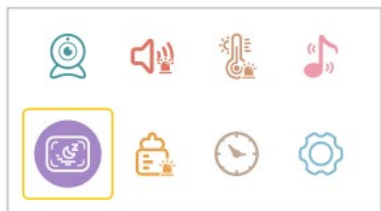

Megjegyzés:



A képernyő automatikusan kigyullad, ha hangjelzés vagy hőmérsékleti riasztás történik.

ETETÉS

Magyarázat:

Ez a funkció emlékezteti Önt a baba etetésére. Az OFF azt jelenti, hogy kikapcsolja a funkciót; a 2,5 óra azt jelenti, hogy 2,5 óránként emlékeztetni fogja Önt, és így tovább a többi opció esetében.

1. lépés

1. Nyomtassa ki a  az ajánlati oldal eléréséhez. Válassza ki a  címet, és nyomja meg a  gombot.
2. Válassza ki a kívánt időt. Az emlékeztető kikapcsolásához válassza az OFF lehetőséget.

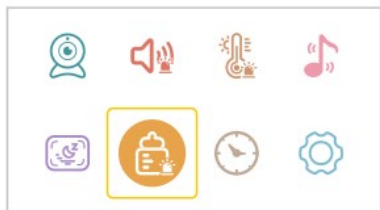



Megjegyzés: Válassza a  lehetőséget a riasztás beállításához a megadott időpontra.

DÁTUM / IDŐ

Magyarázat: Ez a funkció a dátum/idő beállítására, a  be- és kikapcsolására szolgál.

1. lépés

1. Nyomtassa ki a  az ajánlati oldal eléréséhez. Válassza ki a  címet, és nyomja meg a  gombot.

2. Nyomja meg a  gombot a beállítás indításához/leállításához.  a beállítás indítását jelenti.

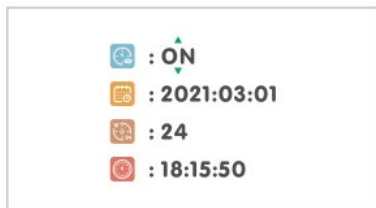
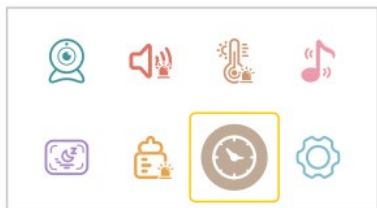

3. A  azt jelenti, hogy a beállítás befejeződött.

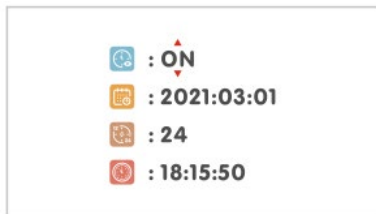

Megjegyzés:

* Nyomja meg a **Fel / Le / Balra / Jobbra** gombokat a kiválasztáshoz, majd nyomja meg az Ok gombot a megerősítéshez.



* Ha a  engedélyezve van, a dátum és az idő megjelenik a monitor állapotsorában, egyébként nem jelenik meg.



BEÁLLÍTÁSOK

Magyarázat:

A gyári beállítások visszaállítása és a szerviztámogatási információk szolgáltatása.

1. lépés

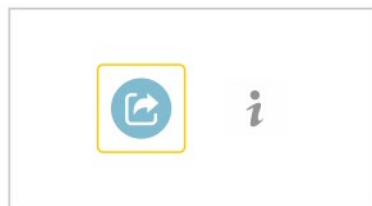
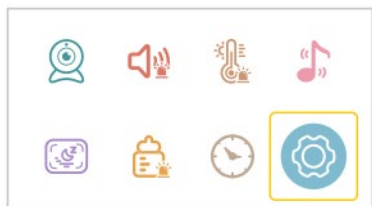

1. Nyomja meg a  gombot a menüoldal eléréséhez. Válassza ki a  címet, és nyomja meg a  gombot.

2. Válassza ki és szabja testre a  . A kezelőfelület eléréséhez nyomja meg a  gombot.

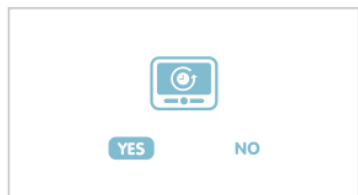

3. **IGEN** a visszaállításhoz. Nyomtassa ki a  vagy akilépéshezállítsa be a **NEM-et**.



1. Válassza ki a  címet. A kezelőfelület eléréséhez nyomja meg a  gombot.

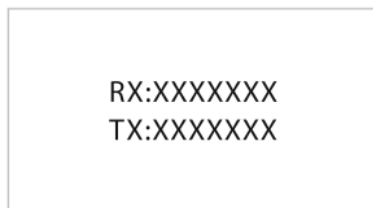
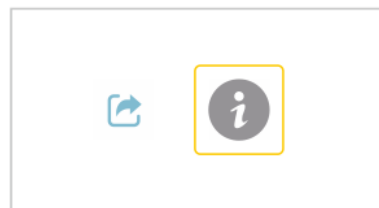







AZ IKONOK MAGYARÁZATA

1. Állapotsori ikonok

| | | | |
|--|------------------------------------|---|-----------------------------------|
|  | Nincs jelkapcsolat |  | Hangérzékelés bekapcsolva |
|  | Jelerősség |  | Hőmérséklet riasztás engedélyezve |
|  | Élő videohurok |  | Emlékeztető etetés megengedett |
|  | Altatódalok engedélyezettek |  | 2x-es nagyítás |
|  | Alvó üzemmód engedélyezve |  | 4x-es nagyítás |
| 27°C | Jelenlegi szobahőmérséklet |  | Éjszakai üzemmód |
|  | Az akkumulátor töltöttségi szintje | VOX | A VOX üzemmód be van kapcsolva |

2. Értésítés az Icons-ról

| | | | |
|--|------------------------------|---|------------------------|
|  | Nincs csatlakoztatott kamera |  | Hőmérséklet riasztás |
|  | Hangjelzés |  | Értésítés az etetésről |

Magyarázat: Az Élő-videó-hurok funkciót a  oldalon található gombok rövid megnyomásával nyithatja meg, amíg az állapotsorban megjelenik a . Ha az Élő-videó-hurok engedélyezve van, a csatlakoztatott kamerák 10 másodpercenként automatikusan váltanak. Ha pedig hangjelzés/hőmérsékleti riasztás történik, a kamerakapcsoló funkció ideiglenesen felfüggesztésre kerül.

GYAKRAN ISMÉTELT KÉRDÉSEK

Q1. Miért nem tudtam a kamerát a monitorhoz csatlakoztatni?

- * Győződjön meg róla, hogy a hálózati adapter szilárdan csatlakozik a fényképezőgéphez és a konnektorhoz.
- * Győződjön meg róla, hogy a kamera és a monitor megfelelő távolságban van.

Q2. Miért olyan homályos az élő videó?

- * Győződjön meg róla, hogy nincs akadály a kamera objektívjén.

Q3. Miért csapott zajt a monitor?

- * A kamera és a monitor túl közel lehet egymáshoz. Helyezze őket nagyobb távolságra.

Q4. Hallhatom a babámat, ha kikapcsolom a képernyőt?

- * Igen. Engedélyeznie kell a Hangérzékelés funkciót, amely hangos hang észlelése esetén felébreszti a képernyőt és hangjelzést vált ki.

Q5. Miért fekete-fehér a kép?

* Az éjjellátó üzemmód akkor aktiválódik, ha a kamera sötét környezetben működik (fényerő < 5 lux).

A garancia **NEM** vonatkozik:

- a készüléket a rendeltetésétől eltérő célokra használja,
- a készülékre telepített firmware-től eltérő firmware telepítése.
- a nem megfelelő használatból eredő elektromos vagy mechanikai károk.
- természetes hatások, például víz, tűz, statikus elektromosság, áramingadozás stb. által okozott károk.
- a szakképzetlen személy által végzett javítások által okozott károk.
- olvashatatlan sorozatszám
- az akkumulátor kapacitása 6 hónapos használat után csökken (6 hónapos élettartam garancia)



Eltávolítás

A terméken, a kísérő dokumentációban vagy a csomagoláson található áthúzott tárolóedény szimbólum azt jelenti, hogy az Európai Unióban minden elektromos és elektronikus berendezést, elemet és akkumulátort élettartamuk végén elkülönített hulladékként kell ártalmatlanítani. Ezeket a termékeket nem szabad válogatatlan települési hulladékként ártalmatlanítani.



MEGFELELŐSÉGI NYILATKOZAT

Az Abacus Electric, s.r.o. kijelenti, hogy az EVOLVEO Baby Monitor NL4 megfelel az ilyen típusú berendezésekre vonatkozó szabványok és előírások követelményeinek.

A megfelelőségi nyilatkozat teljes szövege a <http://ftp.evolveo.com/ce/> oldalon található.

Importőr

Abacus Electric, s.r.o.

Planá 2, 370 01, Csehország

Gyártó

Naxya Limited

Nem. 5, 17/F, Strand 50, 50 Bonham Strand, Sheung Wan, Hongkong

Made in China

Copyright © Abacus Electric, s.r.o.

www.evolveo.com

www.facebook.com/EvolveoCZ

Minden jog fenntartva. A termék megjelenése és műszaki specifikációi előzetes értesítés nélkül változhatnak.

Cuprins







| | |
|---|-----|
| AVERTISMENT | 92 |
| CONȚINUTUL AMBALAJULUI..... | 93 |
| CAMERA..... | 94 |
| MONITOR | 95 |
| CAMERA..... | 98 |
| PENTRU A ÎNCEPE | 98 |
| SETĂRILE CAMEREI | 100 |
| 1. ADĂUGAREA DE CAMERE..... | 100 |
| 2. ÎNDEPĂRTAREA CAMERELOR DE LUAT VEDERI..... | 101 |
| DETECTAREA SUNETULUI..... | 102 |
| ALARMĂ DE ÎNCĂLZIRE..... | 103 |
| CÂNTECE DE LEAGĂN | 104 |
| MOD DE VEGHE | 105 |
| HRĂNIRE | 106 |
| DATA / ORA..... | 107 |
| SETĂRI | 108 |
| EXPLICAȚIA PICTOGRAMELOR..... | 110 |
| ÎNTREBĂRI FRECVENTE | 111 |

AVERTISMENT

Utilizarea necorespunzătoare a produsului poate duce la pericole pentru siguranță. Prin urmare, vă recomandăm insistent să citiți următoarele instrucțiuni înainte de a utiliza produsul.

1. Țineți cablul (cablurile) departe de copii (la cel puțin 1 metru).
2. În cazul unei EROPIERI, vă rugăm să contactați cel mai apropiat centru de service.
3. Utilizați NUMAI adaptoare originale. Utilizarea unor cabluri și adaptoare care nu sunt originale poate deteriora dispozitivul.
4. Dacă nu utilizați adaptorul (adaptoarele), deconectați-l (deconectați-le).
5. Verificați în mod regulat activitățile copilului dumneavoastră, deoarece acest produs nu este destinat pentru supraveghere, ci pentru a asista la supraveghere.

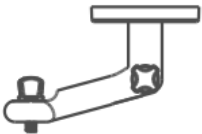
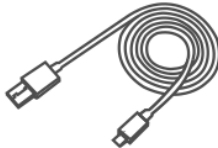
CONȚINUTUL AMBALAJULUI

| | | | |
|--|---|---|--|
|  |  |  | |
| Monitor | Camera | Adaptor de alimentare x2 | |
|  |  |  |  |
| Kit de montare | Suport pentru aparat de fotografiat | Cablu de alimentare x2 | Manual |

CAMERA

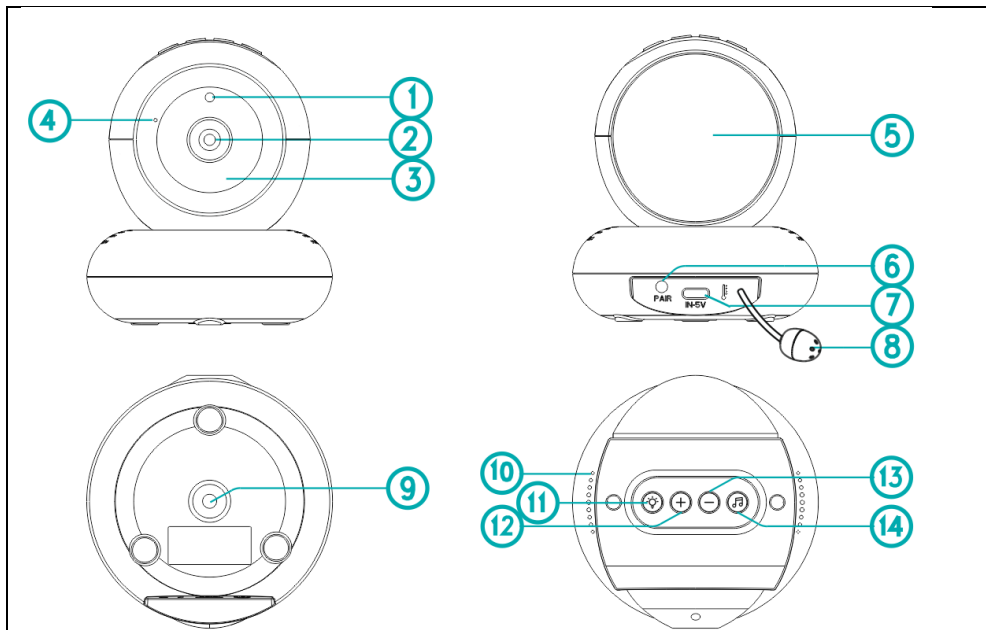

1) Senzor de vedere pe timp de noapte

2) Lentile

3) IR LED

4) Microfon

5) Lumina LED

6) Butonul de împerechere

7) Alimentare USB-C

8) Senzor de temperatură

9) Suport de montare

10) Speaker

11) Butonul LED

12) + Buton

13) - Buton

14) Butonul Lullaby

MONITOR

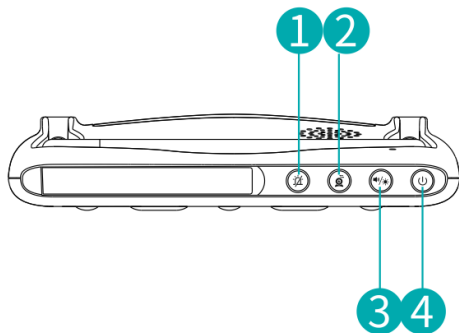

- 1) VOX: mod de ascultare, camera este pornită pentru timpul de așteptare setat și este posibilă monitorizarea evenimentelor din fața camerei.
- 2) Comutatorul camerei: Comutarea camerei, dacă sunt conectate 2 sau mai multe camere, puteți comuta între camere prin apăsarea repetată.
- 3) Volum/luciditatea: Apăsați pentru a regla volumul sau luminozitatea monitorului cu ajutorul săgeților stânga/dreapta și sus/jos.
- 4) Butonul Power/Sleep: Apăsați lung pentru a porni/opri monitorul; apăsați scurt pentru a porni/opri ecranul.
- 5) Nivelul volumului panoului LED: nivelul afișează volumul și intensitatea sunetului detectat de cameră. Albastru > scăzut, portocaliu > mediu, roșu > ridicat.

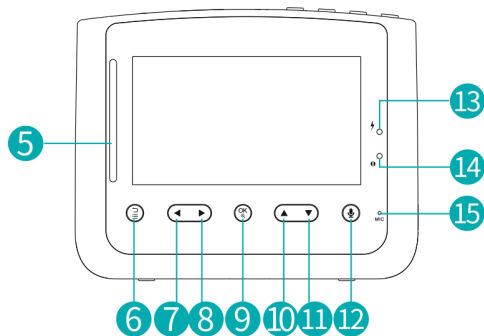

6) Meniu/înapoi: Apăsați butonul pentru a intra în pagina de meniu sau apăsați butonul Back (Înapoi).

7) Stânga: Apăsați butonul pentru a deplasa camera spre stânga sau pentru a schimba selecția spre stânga.

8) Corect: Apăsați butonul pentru a deplasa camera spre dreapta sau pentru a schimba selecția spre dreapta.

9) Zoom/OK: Apăsați butonul pentru a mări/ micșora imaginea sau pentru a confirma selecția.

10) Sus: Apăsați butonul pentru a înclina camera în sus sau pentru a schimba selecția în sus.

11) Jos: Apăsați butonul pentru a înclina camera în jos sau pentru a schimba selecția în jos.

12) Mluvte: Apăsați butonul pentru a vorbi cu copilul.

13) Indicator de încărcare: se aprinde în galben în timp ce monitorul se încarcă.

14) Indicator de performanță: Lumina verde se va aprinde atunci când este conectat la electricitate.

15) Microfon

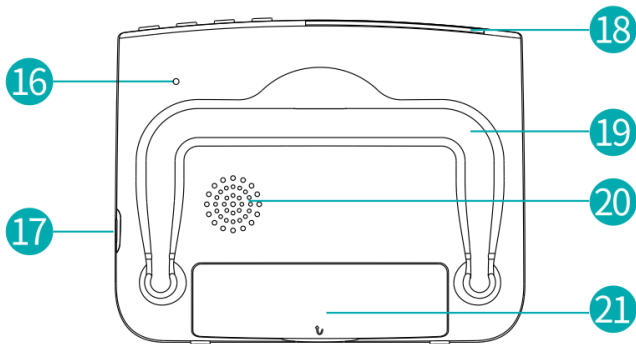

- 16) Resetați gaura
- 17) Conector de alimentare USB-C
- 18) Antena basculantă
- 19) Suport de susținere
- 20) Speaker
- 21) Compartimentul pentru baterii

Observație:

1. Dacă efectuați o RESETARE folosind acest pin, monitorul va fi oprit forțat.
2. Înlocuiți bateria numai cu o baterie originală sau identică, cu specificații identice.

CAMERA

Apăsați butonul LED(11) pentru a aprinde lampa, apăsați-l în mod repetat pentru a schimba culorile. Țineți apăsat pentru a porni modul ciclu. Apăsați butonul +/- (12/13) pentru a modifica intensitatea iluminării LED-ului. Apăsați butonul pentru cântec de leagăn (14) pentru a porni una dintre melodii, apăsați din nou pentru a schimba melodia. Țineți apăsat pentru a opri melodia. Apăsați butonul +/- (12/13) pentru a modifica volumul melodiei.

PENTRU A ÎNCEPE

Pasul 1:



1. Conectați camera la adaptor.
2. Conectați adaptorul de rețea la o priză.

Observație: Așezați camera la distanță de copil (cel puțin 1 m).

Pasul 2:

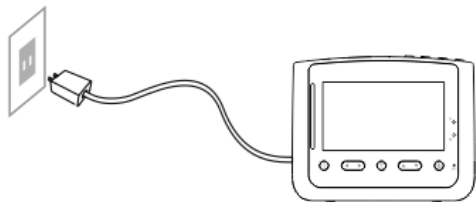

1. Conectați monitorul la adaptor.
2. Conectați adaptorul de rețea la o priză.
3. Apăsăți lung butonul de alimentare pentru a porni monitorul, apoi este afișată interfața de monitorizare.



Observație: Monitorul are nevoie de aproximativ 4 ore pentru a se încărca complet, iar durata de viață a bateriei este de până la 5 ore.

SETĂRILE CAMEREI

Avertisment: Camera și monitorul au fost deja asociate. Această funcție este utilizată pentru a adăuga noi camere la monitor sau pentru a reseta monitorul.

1. Adăugarea de camere

Pasul 1:

1. Apăsați butonul  pentru a intra în pagina de meniu.
2. Selectați  și apăsați butonul .

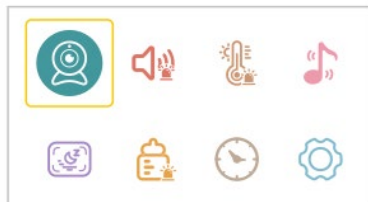

Pasul 2:

1. Selectați  și apăsați .

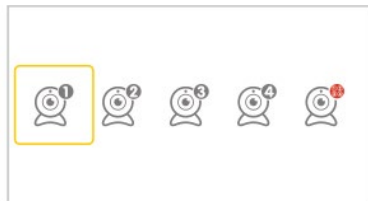

Pasul 3:

1. Selectați  și apăsați de două ori butonul .
2. Apăsați  pentru a începe împerecherea.

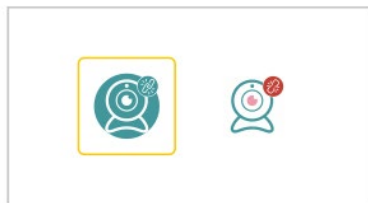



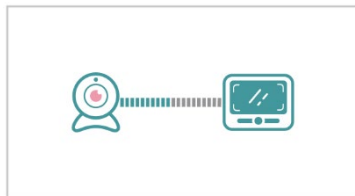

Pasul 4:

1. Apăsați  **PAIR** pe partea din spate a camerei.
2. Apoi va apărea mesajul **Paired (Asociat)**.
Observație: La un monitor pot fi conectate maximum patru camere.



2. Îndepărtarea camerelor de luat vederi

Pasul 1:

1. Imprimați  pentru a accesa pagina ofertei. Selectați  și apăsați **OK** .
2. Selectați camera care trebuie să fie ștersă. Tipărit de pe **OK** .

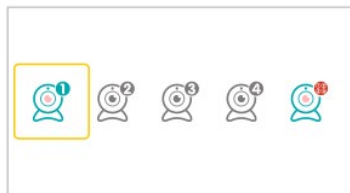
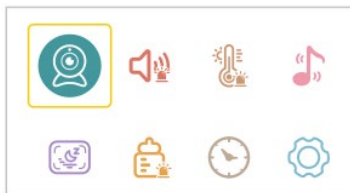

Pasul 2:

1. Selectați pictograma corectă a camerei. Apăsați de două ori butonul **OK** .
2. A se vedea **Eliminat**. Camera dvs. este ștersă.

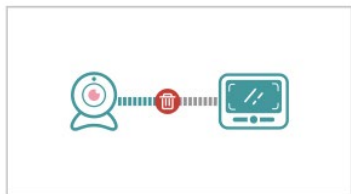
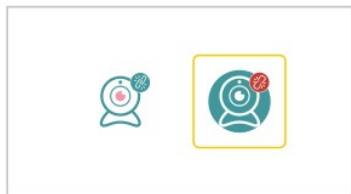





DETECTAREA SUNETULUI

Explicație:

Există patru niveluri de detectare a sunetului: **I** (78 dB), **II** (65 dB), **III** (60 dB) și **OFF**. **I** înseamnă că sunetul poate fi detectat atunci când atinge 78 dB, și așa mai departe pentru **II** și **III**.

Pasul 1:

1. Apăsați  pentru a intra în pagina de meniu. Selectați  și apăsați .
2. Selectați opțiunea dorită. Apăsați .

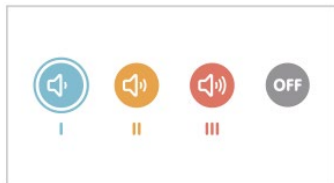
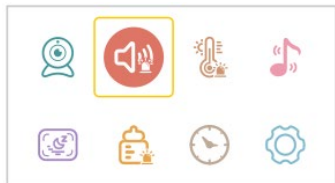

ALARMĂ DE ÎNCĂLZIRE

Explicație:



indică faptul că poate fi setată valoarea temperaturii pentru alarmele de temperatură ridicată și scăzută.

Pasul 1:

1. Apăsați pentru a accesa pagina de meniu. Selectați și apăsați .
2. Selectați opțiunea dorită. Apăsați .

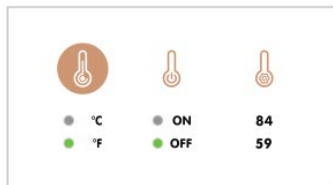
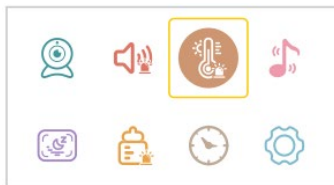

Observație:



Alarma de sunet/temperatură poate fi dezactivată temporar prin apăsarea oricărui buton de pe monitor.

CÂNTECE DE LEAGĂN

Explicație:

Această funcție este utilizată pentru a calma copilul atunci când este necesar.

Pasul 1:

1. Imprimați  pentru a accesa pagina ofertei. Selectați  și apăsați .
2. Selectați cântecul de leagăn dorit. Selectați **ALL(ALL)** pentru a reda cântecele de leagăn în buclă.

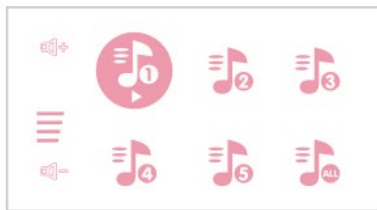
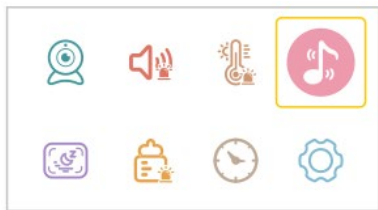



MOD DE VEGHE

Explicație:

Această funcție este utilizată pentru a prelungi durata de funcționare a monitorului prin oprirea ecranului.

Pasul 1:

1. Imprimați  pentru a accesa pagina ofertei. Selectați  și apăsați .
2. Selectați ora dorită.

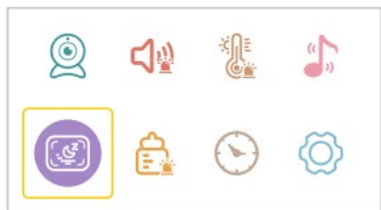

Observație:



Ecranul se va aprinde automat dacă apare o alarmă sonoră sau de temperatură.

HRĂNIRE

Explicație:

Această funcție vă reamintește să vă hrăniți copilul. OFF înseamnă că dezactivați funcția; 2,5 ore înseamnă că vă va reaminti la fiecare 2,5 ore, și așa mai departe pentru celelalte opțiuni.

Pasul 1:

1. Imprimați  pentru a accesa pagina ofertei. Selectați  și apăsați .
2. Selectați ora dorită. Selectați OFF pentru a dezactiva memento-ul.

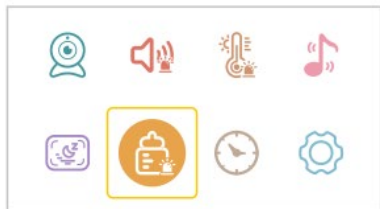





Observație: Selectați  pentru a seta alarma pentru ora specificată.

DATA / ORA

Explicație: Această funcție este utilizată pentru a seta data/ora, pentru a porni/opri



Pasul 1:

1. Imprimați  pentru a accesa pagina ofertei. Selectați  și apăsați  .
2. Apăsați butonul  pentru a începe/opri configurarea.  înseamnă începerea configurației.

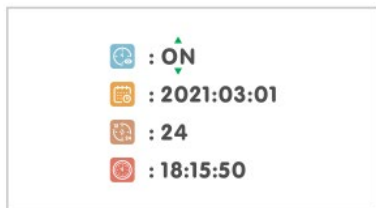
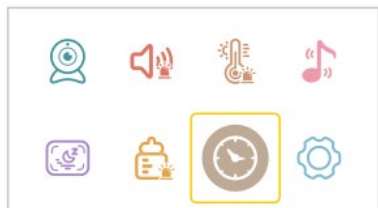

3.  înseamnă că configurarea este completă.

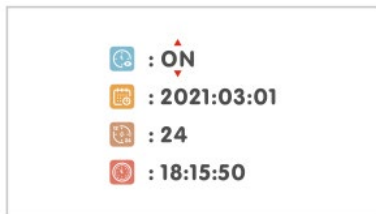

Observație:

* Apăsați butoanele **Sus / Jos / Stânga / Dreapta** pentru a selecta și apăsați butonul Ok pentru a confirma.





* Dacă  este activat, data și ora vor fi afișate în bara de stare a monitorului; în caz contrar, nu vor fi afișate.

SETĂRI

Explicație:

Restaurați setările din fabrică și furnizați informații de asistență tehnică.

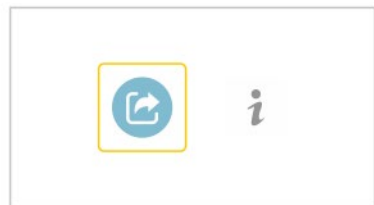
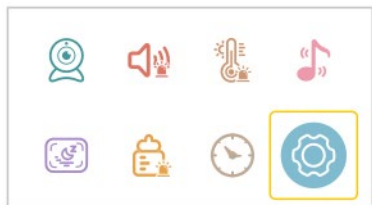

Pasul 1:

1. Apăsați  pentru a accesa pagina de meniu. Selectați  și apăsați .
2. Selectați și personalizați . Pentru a accesa interfața, apăsați butonul .

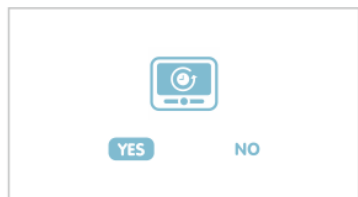

3. **DA** pentru resetare. Imprimați  sau personalizați **NU** pentru aieși.





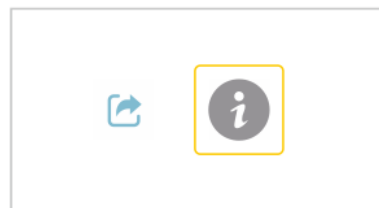









1. Selectați . Pentru a accesa interfața, apăsați butonul .









EXPLICAȚIA PICTOGRAMELOR

1. Pictogramele din bara de stare

| | | | |
|--|---------------------------------|---|------------------------------------|
|  | Nici o conexiune de semnal |  | Detectarea sunetului pe |
|  | Puterea semnalului |  | Alarma de temperatură activată |
|  | Bucula video live |  | Amintirile de hrănire sunt permise |
|  | Cântece de leagăn permise |  | mărire 2x |
|  | Modul de veghe activat |  | mărire 4x |
| 27°C | Temperatura curentă a camerei |  | Modul de noapte |
|  | Nivelul de încărcare a bateriei | VOX | Modul VOX este activat |

2. Notificarea de Icons

| | | | |
|--|-------------------------|---|------------------------|
|  | Nici o cameră conectată |  | Alarma de temperatură |
|  | Alarma sonoră |  | Notificarea de hrănire |

Explicație: Puteți deschide funcția Live-Video-Loop prin apăsarea scurtă a butoanelor de pe  până când în bara de stare apare . Atunci când este activată funcția Live-Video-Loop, camerele conectate se schimbă automat la fiecare 10 secunde. Iar dacă apare o alarmă sonoră/temperatură, funcția de comutare a camerei este suspendată temporar.

ÎNTREBĂRI FRECVENTE

Q1. De ce nu am putut conecta camera la monitor?

* Asigurați-vă că adaptorul de alimentare este conectat ferm la aparatul foto și la priză.

* Asigurați-vă că aparatul foto și monitorul se află la o distanță eficientă.

Q2. De ce este atât de neclară înregistrarea video în direct?

* Asigurați-vă că nu există niciun obstacol pe obiectivul camerei.

Q3. De ce făcea zgomot monitorul?

* Camera și monitorul pot fi prea apropiate. Așezați-le la o distanță mai mare.

Q4. Pot să-mi aud copilul dacă închid ecranul?

* Ano. Ar trebui să activați funcția de detectare a sunetului, care trezește ecranul și declanșează o alarmă sonoră în cazul în care este detectat un sunet puternic.

Q5. De ce este imaginea alb-negru?

* Modul de viziune nocturnă este activat atunci când camera funcționează într-un

mediu întunecat (luminozitate < 5 lux).

Garanția NU acoperă:

- utilizarea dispozitivului în alte scopuri decât cele pentru care este destinat,
- instalarea unui alt firmware decât cel instalat pe dispozitiv.
- deteriorări electrice sau mecanice cauzate de o utilizare necorespunzătoare.
- deteriorări cauzate de influențe naturale, cum ar fi apa, focul, electricitatea statică, fluctuațiile de tensiune etc.
- daunele cauzate de reparațiile efectuate de o persoană necalificată.
- număr de serie ilizibil
- capacitatea bateriei va scădea după 6 luni de utilizare (garanție de 6 luni pentru durata de viață a bateriei)



Eliminare

Simbolul containerului barat pe produs, în documentația de însoțire sau pe ambalaj înseamnă că toate echipamentele electrice și electronice, bateriile și acumulatorii din Uniunea Europeană trebuie eliminate ca deșeuri separate la sfârșitul duratei lor de viață. Aceste produse nu trebuie să fie eliminate ca deșeuri municipale nesortate.



DECLARAȚIE DE CONFORMITATE

Abacus Electric, s.r.o. declară prin prezenta că monitorul pentru copii EVOLVEO NL4 îndeplinește cerințele standardelor și reglementărilor aplicabile acestui tip de echipament.

Textul integral al Declarației de conformitate poate fi consultat la adresa <http://ftp.evolveo.com/ce/>.

Importator
Abacus Electric, s.r.o.
Planá 2, 370 01, Republica Cehă

Producător
Naxya Limited
No. 5, 17/F, Strand 50, 50 Bonham Strand, Sheung Wan, Hongkong
Fabricat în China

Copyright © Abacus Electric, s.r.o.
www.evolveo.com
www.facebook.com/EvolveoCZ

Toate drepturile rezervate. Aspectul produsului și specificațiile tehnice se pot modifica fără notificare prealabilă.

PRODUCT PARAMETER

| | | |
|---|---------------------------------------|----|
| Manufacturer's name or trade mark, commercial registration number and address | Shenzhen Flypower Technology Co., Ltd | - |
| Model identifier | PS10UA050K2000EU | - |
| Input voltage | 100-240 | V |
| Input AC frequency | 50/60 | Hz |
| Output voltage | 5 | V |
| Output current | 2 | A |
| Output power | 10 | W |
| Average active efficiency | 78,7 | % |
| Efficiency at low load (10 %) | X,X | % |
| No-load power consumption | 0,1 | W |