



# G528C

## RGB GAMING HEADPHONE

ENC NOISE CANCELLING TECHNOLOGY



Black







# G528C



## 7.1 Virtual Surround Sound

Virtually immerse yourself and experience true directional sound.



## Environmental Noise Cancellation

Dual ENC noise cancelling microphones filter most ambient noises to deliver and receive crystal clear vocals.

## KNOW YOUR PRODUCT

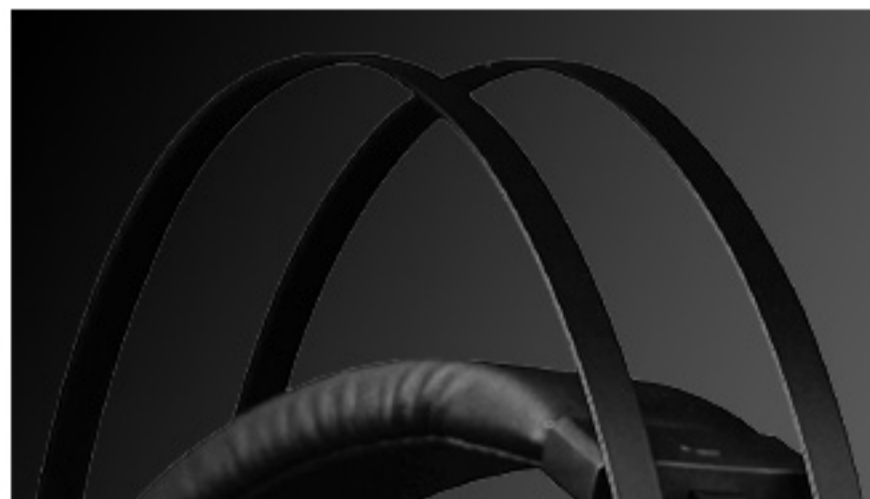

Dual Support Metal Headband

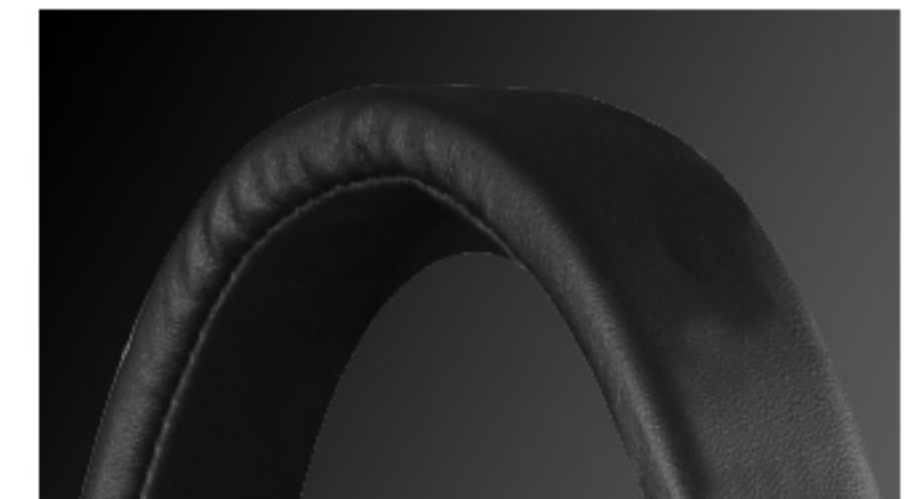

Leather Padded Headband

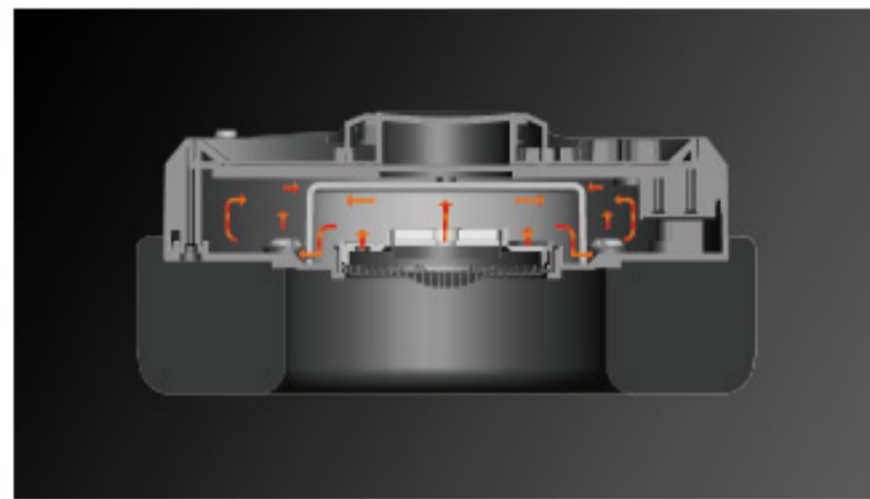

Dual-Chamber Design Speaker

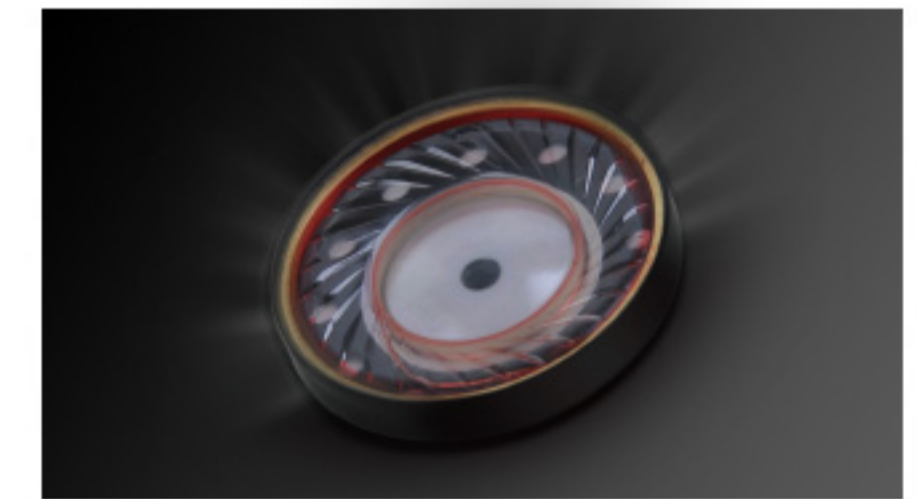

50 mm Speaker Unit

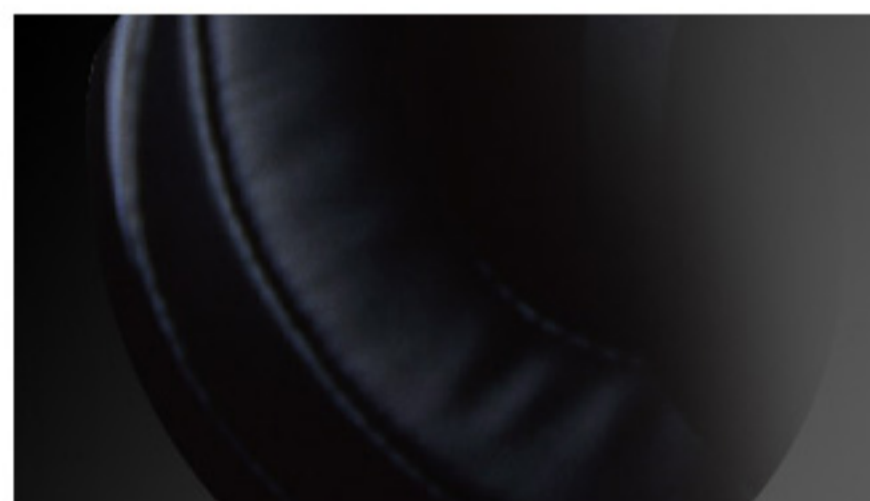

Ergonomic 3D Earpads



RGB Flow Backlight

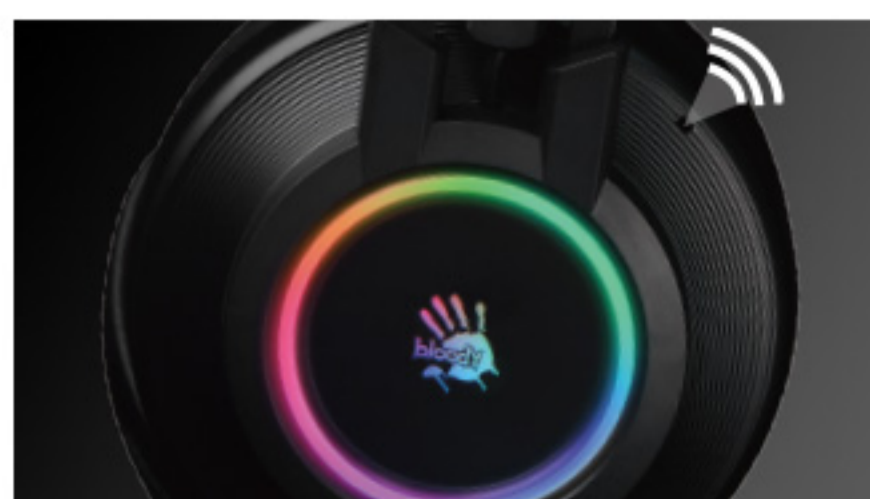

ENC Noise Cancelling Technology



Omni-Directional Microphone



Adjustable Volume Control

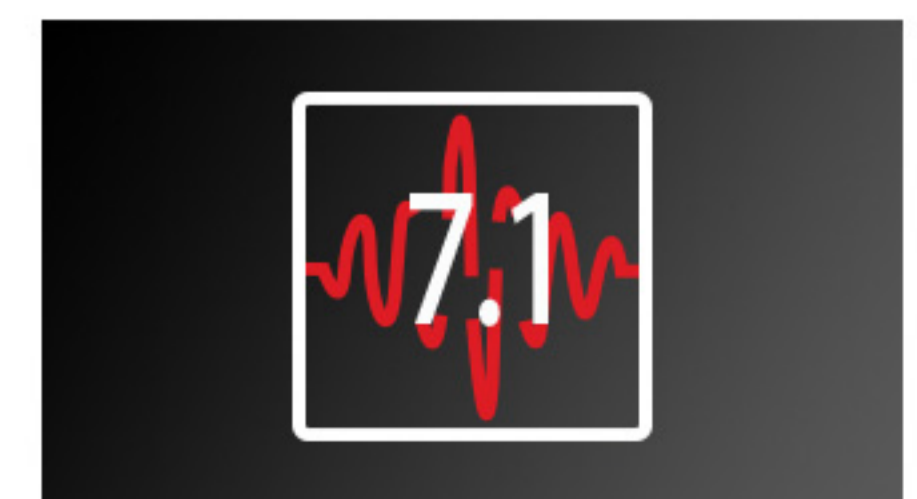

7.1 Virtual Surround Sound





# G528C

## TECH SPECS

### HEADPHONE

Speaker Unit: 50 mm with Neodymium Magnet  
Frequency Response: 20 Hz - 20 KHz

Sensitivity: 105 dB  
Impedance: 16 ohm

### MIC.

Frequency Response: 100 Hz -10 KHz  
Sensitivity: -33 dB

### CABLE

Cable Length: 200 CM  
Connector: USB Plug

## PACKAGE CONTENTS

USB Headset

## SYSTEM REQUIREMENT

Windows 7 / 8 / 8.1 / 10

## PRODUCT SIZE

